

# Artisan Collection

Designed By  
Berry & Clark Design Associates



**PLANUM**<sup>®</sup>  
FURNITURE

Planum, Inc  
Swedesford Corporate Center  
619 B Swedesford Road  
Frazer, PA 19355

Tel : 610/251-2120  
Tel : 800/343-0042  
Fax : 610/251-2290

email [info@planumfurniture.com](mailto:info@planumfurniture.com)  
visit us [planumfurniture.com](http://planumfurniture.com)

# ARTISAN COLLECTION

Artisan the noun refers to a skilled worker or craftsman. Artisan the collection refers to the finest beginning of quality European case goods offered by Planum to date. Creating something truly new and different in today's world of contemporary furnishing is easier said than done. While often the norm to offer similar designs that exists in the marketplace, it is the true Artisan that can create something fresh, inviting and unique. This is Artisan!

Clean and concise on the outside, sculptural and artful within, Artisan offers an exacting combination of shape, design and materials that makes it like no other. Each piece of each door is hand veneered using quartered white oak veneers and applied to create a sculptural dimension to the case. Custom steel accents add a sleek contemporary refinement to the pieces. Storage and function co-exist within this special design offering.

Being unique in materials and design are not the only quality of Artisan. Today's discerning consumer desires the opportunity of choice when creating their environment. As with most Planum case goods, this has been true and never truer than with Artisan. The ability to custom create multiple finish and veneer combinations gives every consumer the opportunity to define their space in ways not often accommodated.

This is the beginning of Artisan. The end is nowhere in sight!

## Table of Contents

	Page #
Dining Room	5-9
Curios & Storage Cabinets	10
Occasional	11
Home Office	12-13
Bedroom	14-19
Artisan II (Walnut)	20

# Artisan Wood Finishes/ Accent Finishes

Water based stain finishes on oak-open pore  
(5% Sheen)



AR100 Bleached White Oak



AR101 Patina Oak



AR102 Bleached Gray Oak



AR103 Light Gray Oak



AR104 Medium Gray Oak



AR105 Dark Gray Oak



AR106 Wenge Oak



AR107 Graphite Oak



Gold Leaf



Silver Leaf

**Please Note:** All metal accents in combination with Oak are in polished stainless steel.

# Artisan

## Painted Finishes on Open-Pore Oak (5% Sheen)



AR200 White Open-Pore Lacquer  
(Blanco)



AR201 Riga Open-Pore Lacquer

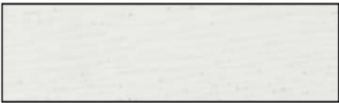

AR202 Colina Open-Pore Lacquer



AR203 Gray Stone Open-Pore Lacquer  
(Gris Piedra)



AR204 Sputnik Open-Pore Lacquer



AR205 Gothic Open-Pore Lacquer  
(Gotico)



AR206 Black Open-Pore Lacquer  
(Negro Bulgari)

## Lacquer Finishes (50% Sheen)



AR300 White Lacquer  
(Blanco)



AR301 Riga Lacquer

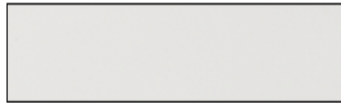

AR302 Colina Lacquer

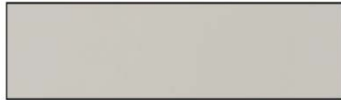

AR303 Gray Stone Lacquer  
(Gris Piedra)



AR304 Sputnik Lacquer

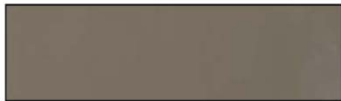

AR305 Gothic Lacquer  
(Gotico)



AR306 Black Lacquer  
(Negro Bulgari)



AR307 #9010 White Lacquer  
(9010 Blanco)

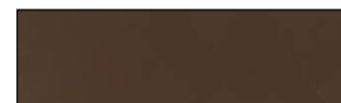

AR308 VD115 Lacquer



AR309 Basalt Lacquer  
(Basalto)



AR310 Carriage Red Lacquer  
(Carruaje)

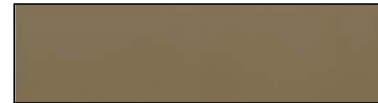

AR311 Khartoum Lacquer  
(Jartum)



AR312 Accero Lacquer



AR313 Ivory Lacquer  
(Avorio)



AR319 Stone Lacquer  
(Piedra)



AR320 Clear Beige Lacquer  
(Beige Claro)



AR321 Brass Lacquer  
(Laton)



AR322 Copper Lacquer  
(Cobre)



Bronze Lacquer  
(Bronce)

**\*\*\* 5% UPCHARGE FOR HIGH GLOSS LACQUER\*\*\***

Dining Room	Item No. Description	Dimension in inches		
		W	H	D

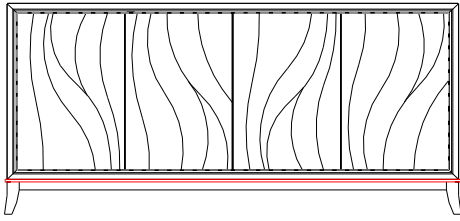

**16000**  
 Credenza on Wooden legs  
 4 Doors  
 1 Interior Drawer  
 1 Bottle Storage  
 5 Adjustable Shelves

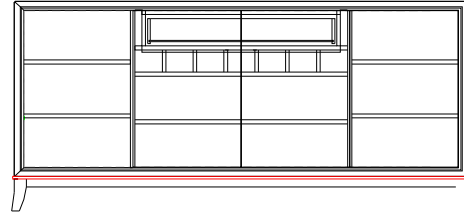

79 1/2"      39 3/8"      20 1/2"

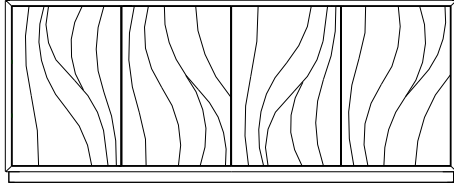

**16001**  
 Credenza on Plinth  
 4 Doors  
 1 Interior Drawer  
 1 Bottle Storage  
 5 Adjustable Shelves

79 1/2"      35 1/2"      20 1/2"

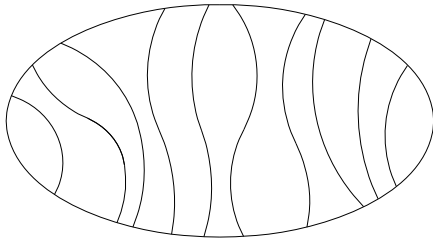

**16008**  
 Oval Dining Table w/ Metal/Wood Pedestal  
 1 Removable Center Extension 23 5/8" Wide

88 1/8"      30"      54"

*Please Note: Table top cannot be done in two different finishes.  
 The "two-toned" effect is achieved by altering the veneer direction.  
 Painted finishes will not result in the "two-toned" effect.*

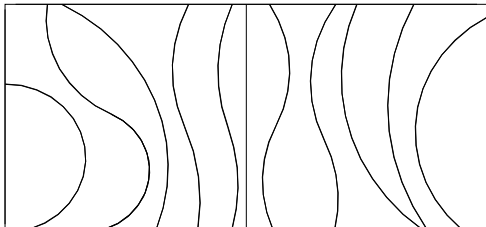
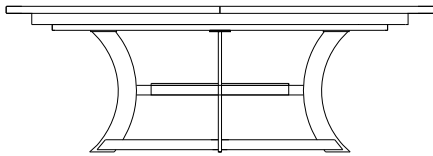

**16127**  
 Rectangular Dining Table w/ Metal/Wood Pedestal  
 1 Removable Center Extension 23 5/8" Wide  
 Plain Veneer

90 1/2"      30"      45 1/4"

*Please Note: Table top cannot be done in two different finishes.  
 The "two-toned" effect is achieved by altering the veneer direction.  
 Painted finishes will not result in the "two-toned" effect.*

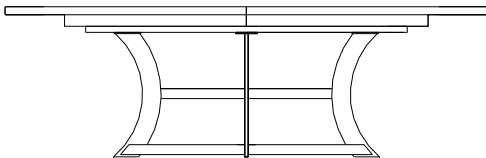

Dining Room	Item No. Description	Dimension in inches		
		W	H	D

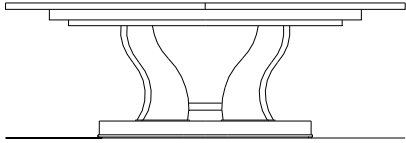
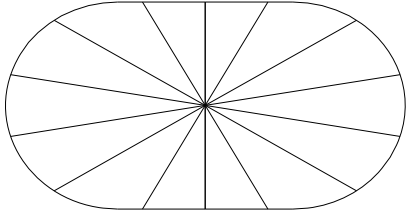

**16028** 82 1/4" 30" 46"

Race Track Oval Dining Table  
1 Removable Center Extension 23 5/8" Wide

*Please Note: Table top cannot be done in two different finishes.  
The "two-toned" effect is achieved by altering the veneer direction.  
Painted finishes will not result in the "two-toned" effect.*

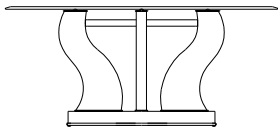
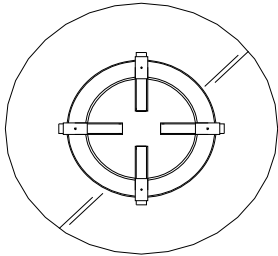

**16030** 63" 30 63"

Round Dining Table incl 63" diameter glass top

**16032** 59" 30 59"

Round Dining Table incl 59" diameter glass top

**16033** 55 1/8" 30 55 1/8"

Round Dining Table incl 55 1/8" diameter glass top

**16031**  
BASE ONLY for Round Dining Table

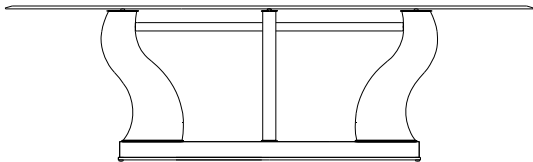
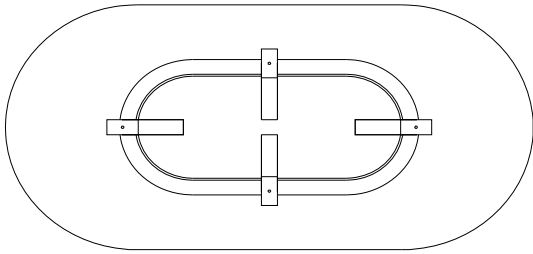

**16029** 94 1/2" 30" 47 1/4"

Oval Dining Table w/ Metal/Wood Pedestal

**16027**  
BASE ONLY for Oval Dining Table

Dining Room	Item No. Description	Dimension in inches		
		W	H	D

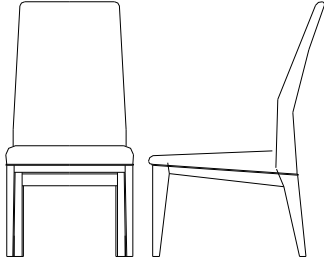

**Side Chair**

Solid Oak Frame

Seat Height: 19"  
Seat Depth: 19 1/2"

**C.O.M. Requirements:**

1 3/4 YARD OF 55" PLAIN FABRIC

<b>16010/B</b> Faux Leather	19 7/8"	43 1/4"	28"
<b>16010/C</b> Fabrics-Grade C/ C.O.M.			
<b>16010/D</b> Fabrics-Grade D			
<b>16010/E</b> Fabrics-Grade E/ Ultrasuede			
<b>16010/F</b> Fabrics-Grade F			
<b>16010/G</b> Fabric-Grade G			
<b>16010/P1</b> Leather Serie 100/ Mastrotto Leather			

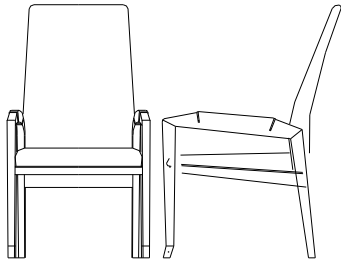

**Arm Chair**

Solid Oak Frame

Seat Height: 19"  
Seat Depth: 20"  
Arm Height: 25 3/8"

**C.O.M. Requirements:**

1 3/4 YARD OF 55" PLAIN FABRIC

<b>16012/B</b> Faux Leather	21 7/8"	43 1/4"	28"
<b>16012/C</b> Fabrics-Grade C/ C.O.M.			
<b>16012/D</b> Fabrics-Grade D			
<b>16012/E</b> Fabrics-Grade E/ Ultrasuede			
<b>16012/F</b> Fabrics-Grade F			
<b>16012/G</b> Fabric-Grade G			
<b>16012/P1</b> Leather Serie 100/ Mastrotto Leather			

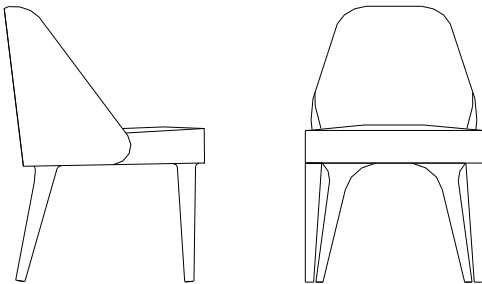

**Upholstered Dining Chair**

**C.O.M. REQUIREMENT:**

2 1/2 YARDS OF 55" PLAIN FABRIC

<b>Upholstered Dining Chair</b> w/ Wooden Legs	19 7/8"	33 1/2"	22 1/2"
<b>16132/B</b> Faux Leather			
<b>16132/C</b> Fabrics-Grade C/ C.O.M.			
<b>16132/D</b> Fabrics-Grade D			
<b>16132/E</b> Fabrics-Grade E/ Ultrasuede			
<b>16132/P1</b> Leather Serie 100/ Mastrotto Leather			

Dining Room	Item No. Description	Dimension in inches		
		W	H	D

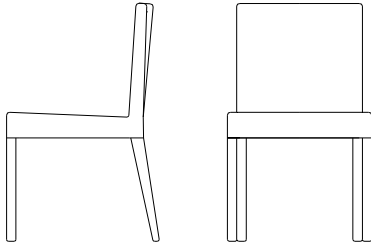

**Side Chair**

Seat Height: 17 3/4"

**C.O.M. Requirement:**

1 1/2 yards of 55"W Plain Fabric

<b>Side Chair</b>	19 1/8"	32 1/4"	22"
<b>16130/B</b> Faux Leather			
<b>16130/C</b> Fabrics-Grade C/ C.O.M.			
<b>16130/D</b> Fabrics-Grade D			
<b>16130/E</b> Fabrics-Grade E/ Ultrasuede			
<b>16130/P1</b> Leather Serie 100/ Mastrotto Leather			

**\*\*Legs & Arms Only Available in Lacquer Finishes; Top Rail Available in Lacquer or Oak\*\***

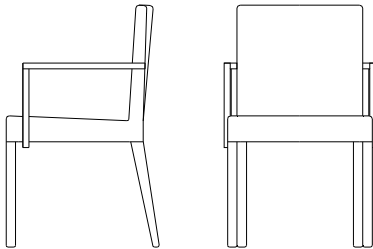

**Arm Chair**

Seat Height: 17 3/4"  
Arm Height: 25 1/4"

**C.O.M. Requirement:**

1 1/2 yards of 55"W Plain Fabric

<b>Arm Chair</b>	21"	32 1/4"	22"
<b>16131/B</b> Faux Leather			
<b>16131/C</b> Fabrics-Grade C/ C.O.M.			
<b>16131/D</b> Fabrics-Grade D			
<b>16131/E</b> Fabrics-Grade E/ Ultrasuede			
<b>16131/P1</b> Leather Serie 100/ Mastrotto Leather			

**\*\*Legs & Arms Only Available in Lacquer Finishes; Top Rail Available in Lacquer or Oak\*\***

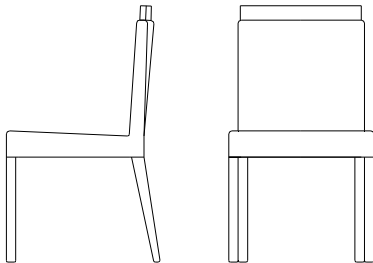

**Side Chair**

Seat Height: 17 3/4"

**C.O.M. Requirement:**

1 1/2 yards of 55"W Plain Fabric

<b>Side Chair w/ Top Rail</b>	19 1/8"	32 1/4"	22"
<b>16133/B</b> Faux Leather			
<b>16133/C</b> Fabrics-Grade C/ C.O.M.			
<b>16133/D</b> Fabrics-Grade D			
<b>16133/E</b> Fabrics-Grade E/ Ultrasuede			
<b>16133/P1</b> Leather Serie 100/ Mastrotto Leather			

**\*\*Legs & Arms Only Available in Lacquer Finishes; Top Rail Available in Lacquer or Oak\*\***



Dining Room	Item No. Description	Dimension in inches		
		W	H	D

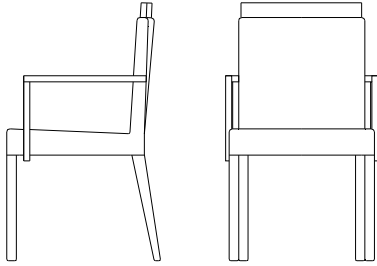

**Arm Chair**

Seat Height: 17 3/4"  
Arm Height: 25 1/4"

**C.O.M. Requirement:**  
1 1/2 yards of 55"W Plain Fabric

**Arm Chair**  
w/ Top Rail

21"      34 1/2"      22"

**16134/B**  
Faux Leather

**16134/C**  
Fabrics-Grade C/ C.O.M.

**16134/D**  
Fabrics-Grade D

**16134/E**  
Fabrics-Grade E/ Ultrasuede

**16134/P1**  
Leather Serie 100/ Mastrotto Leather

**\*\*Legs & Arms Only Available in Lacquer Finishes; Top Rail Available in Lacquer or Oak\*\***

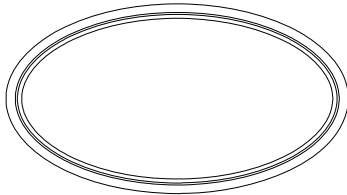

**16070**  
Oval Mirror

60"      36"      2"

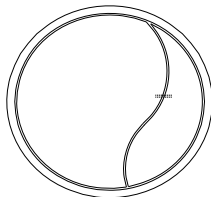

**16072**  
Round Mirror

39 3/8"      39 3/8"      2"

Curio & Storage Cabinets	Item No. Description	Dimension in inches		
		W	H	D

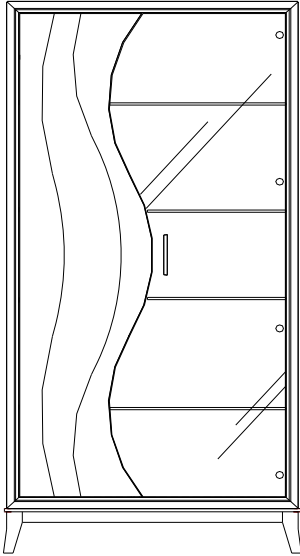

**16002 (LEFT)**                    39 3/4"            80 3/4"            19 5/8"  
 Curio Showcase  
 2 Interior Drawers behind Wooden Door

**16003 (RIGHT)**                    39 3/4"            80 3/4"            19 5/8"  
 Curio Showcase  
 2 Interior Drawers behind Wooden Door

**16004**  
 Upcharge for LED Lights

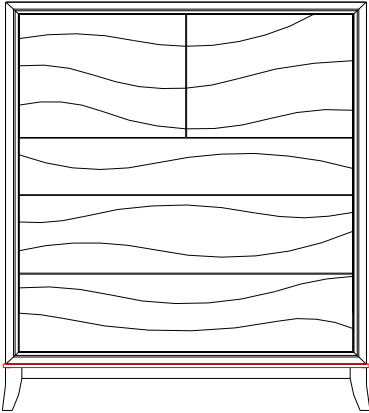

**16022**                                    47 5/8"            57 1/2"            19 1/4"  
 Chest w/ doors & 3 drawers

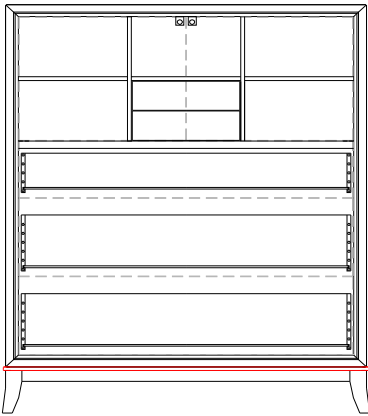

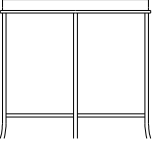
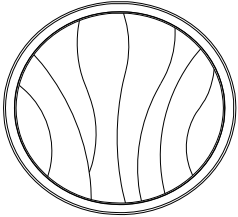
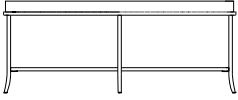
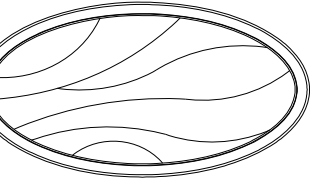
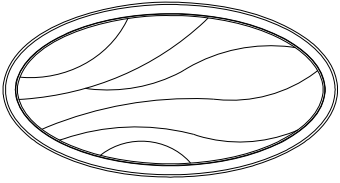
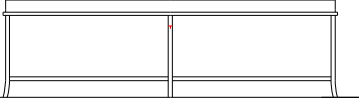
Occasional	Item No. Description	Dimension in inches		
		W	H	D
	<b>16035</b>	25 3/4"	26"	25 3/4"
	Round Lamp Table w/ Metal Base			
	<b>16036</b>	39 3/8"	17"	39 3/8"
	Round Cocktail Table W/ Metal Base			
	<b>16041</b>	51 1/8"	17"	51 1/8"
	Round Cocktail Table W/ Metal Base			
	<b>16038</b>	50 3/4"	17"	28 3/4"
	<b>16040</b> Oval Cocktail Table w/ Metal Base	63"	17"	35 1/2"

Home Office	Item No. Description	Dimension in inches		
		W	H	D

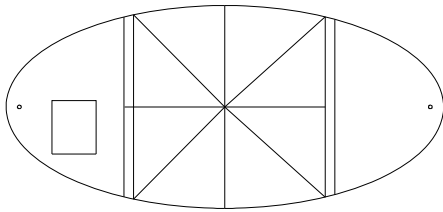

**16074**

73 5/8"

30 1/8"

37

Oval Desk w/ Metal Legs  
w/ two 2 drawer pedestals  
Glass Ends

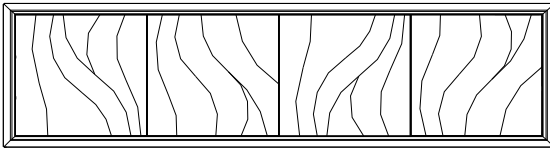
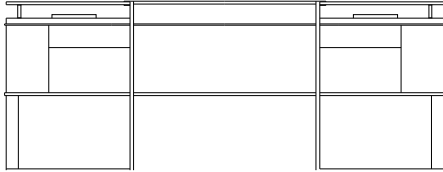

**16080**

78 3/4"

22 1/4"

17"

Wall Mounted Unit  
w/ 4 interior drawers & 2 shelves behind center doors

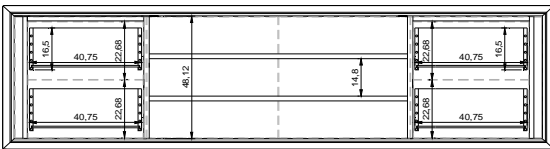

**16080/UPCH**

Upcharge for 1 file drawer to replace 2 interior drawers in outside sections

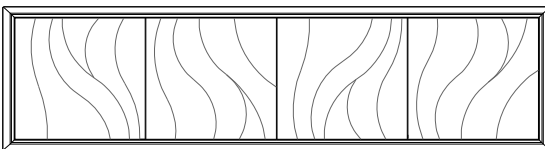

**16080/S**

78 3/4"

22 1/4"

17"

Wall Mounted Unit  
w/ 2 shelves in center section  
w/ 1 shelf each in the outside sections

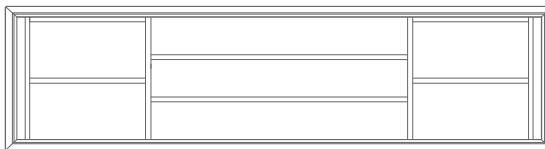

**16080/SUPCH**

Upcharge for 1 interior drawer

Home Office	Item No. Description	Dimension in inches		
		W	H	D

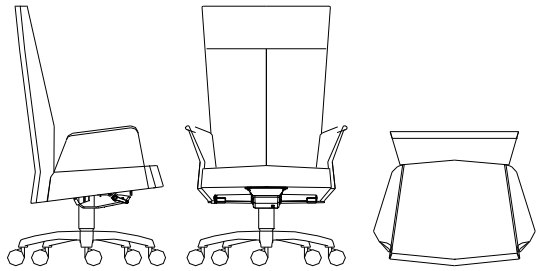

**Executive Chair**                      31 1/2              47 1/4              26 3/4

<b>8722/B</b>	Fabric-Grade B/ Faux Leather	
<b>8722/C</b>	Fabric-Grade C/C.O.M	
<b>8722/D</b>	Fabric-Grade D	
<b>8722/E</b>	Fabric-Grade E/ Ultrausede	
<b>8722/F</b>	Fabric-Grade F	
<b>8722/G</b>	Fabric-Grade G	
<b>8722/P1</b>	Leather Serie 100/ Mastrotto Leather	

C.O.M. Requirement: 3 1/2 yards of 55"W Plain Fabric

C.O.L. Requirement: 52 Sq Ft

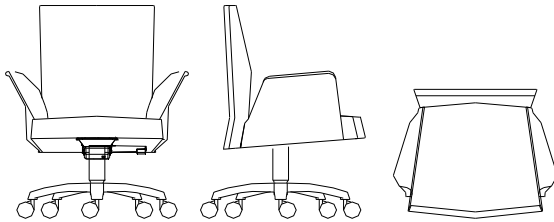

**Desk Chair**                              31 1/2              33 1/2              26 3/4

<b>11594/B</b>	Fabric-Grade B/ Faux Leather	
<b>11594/C</b>	Fabric-Grade C/C.O.M	
<b>11594/D</b>	Fabric-Grade D	
<b>11594/E</b>	Fabric-Grade E/ Ultrausede	
<b>11594/F</b>	Fabric-Grade F	
<b>11594/G</b>	Fabric-Grade G	
<b>11594/P1</b>	Leather Serie 100/ Mastrotto Leather	

C.O.M. Requirement: 3 1/2 yards of 55"W Plain Fabric

C.O.L. Requirement: 52 Sq Ft

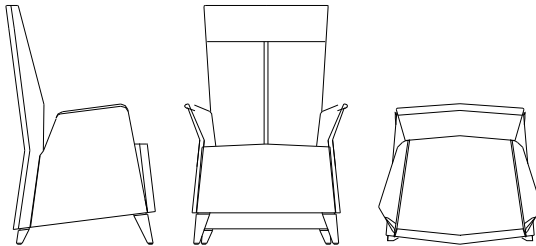

**Guest Armchair**                      32 1/4              44              26 3/4

<b>8720/B</b>	Fabric-Grade B/ Faux Leather	
<b>8720/C</b>	Fabric-Grade C/C.O.M	
<b>8720/D</b>	Fabric-Grade D	
<b>8720/E</b>	Fabric-Grade E/ Ultrausede	
<b>8720/F</b>	Fabric-Grade F	
<b>8720/G</b>	Fabric-Grade G	
<b>8720/P1</b>	Leather Serie 100/ Mastrotto Leather	

C.O.M. Requirement: 4 yards of 55"W Plain Fabric

C.O.L. Requirement: 65 Sq Ft

Bedroom	Item No. Description	Dimension in inches		
		W	H	D

## Panel Beds

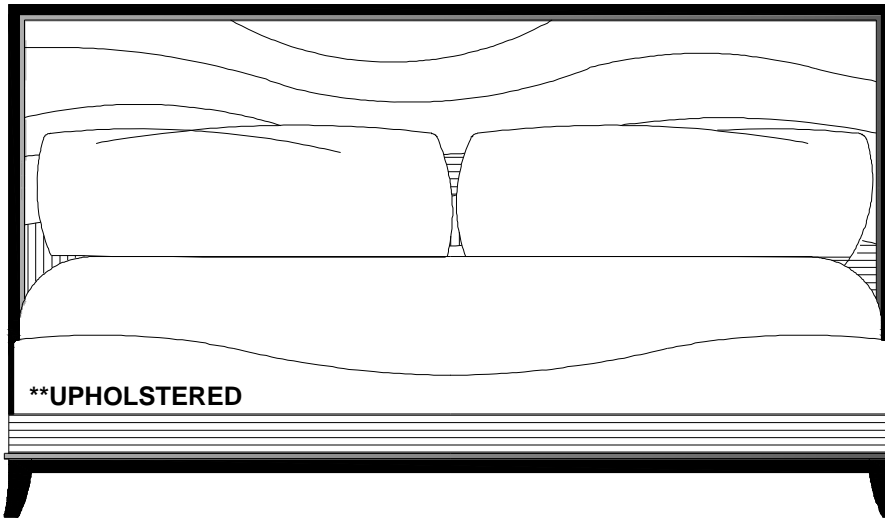

**C.O.M REQUIREMENT FOR ALL SIZES: 2 1/2 YARDS OF 55" W PLAIN FABRIC**

### Queen Size Panel Bed

65 1/2"      52 1/4"      85 3/8"

16052/B	Grade B Fabrics/ Faux Leather	
16052/C	Grade C Fabrics/ COM	
16052/D	Grade D Fabrics	
16052/E	Grade E Fabrics/ Ultrasuede	
16052/F	Grade F Fabrics	
16052/G	Grade G Fabrics	
160528P1	Leather 1- Serie 100/ Mastrotto Leather	

### King Size Panel Bed

81 1/2"      52 1/4"      85 3/8"

16050/B	Grade B Fabrics/ Faux Leather	
16050/C	Grade C Fabrics/ COM	
16050/D	Grade D Fabrics	
16050/E	Grade E Fabrics/ Ultrasuede	
16050/F	Grade F Fabrics	
16050/G	Grade G Fabrics	
16050/P1	Leather 1- Serie 100/ Mastrotto Leather	

### California King Size Panel Bed

77 1/2"      52 1/4"      89 1/4"

16051/B	Grade B Fabrics/ Faux Leather	
16051/C	Grade C Fabrics/ COM	
16051/D	Grade D Fabrics	
16051/E	Grade E Fabrics/ Ultrasuede	
16051/F	Grade F Fabrics	
16051/G	Grade G Fabrics	
16051/P1	Leather 1- Serie 100/ Mastrotto Leather	

Bedroom	Item No. Description	Dimension in inches		
		W	H	D

**Panel Headboards Only**

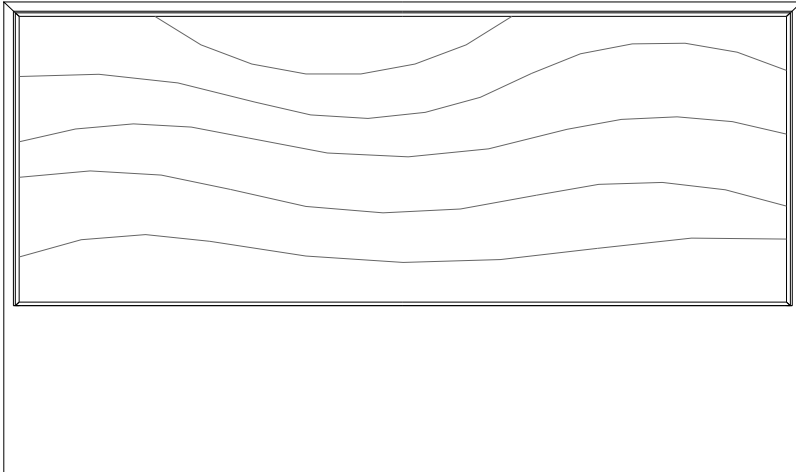

**Queen Size Panel Bed ( Headboard ONLY)**

65 1/2"      52 1/4"      2"

16055	
-------	--

**King Size Panel Bed ( Headboard ONLY)**

81 1/2"      52 1/4"      2"

16053	
-------	--

**California King Size Panel Bed ( Headboard ONLY)**

77 1/2"      52 1/4"      2"

16054	
-------	--

Bedroom	Item No. Description	Dimension in inches		
		W	H	D

## Bed w/ Upholstered Headboard & Upper Bed Frame

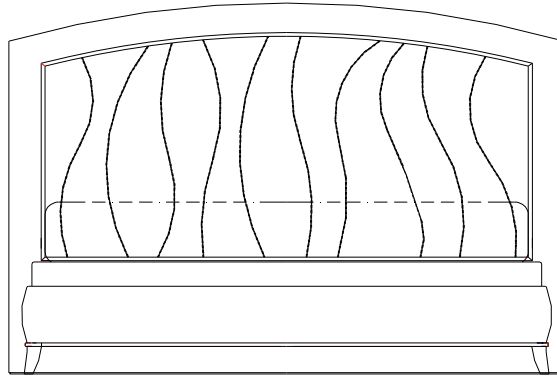

### Upcharge for Headboard LED Lights

16097	
-------	--

### Queen Size Bed w/ Upholstered Headboard

C.O.M. Requirement: 5 yards of 55" W Plain Fabric

C.O.L. Requirement: 54 sq ft

71"      59"      92"

16062/B	Grade B Fabrics/ Faux Leather	
16062/C	Grade C Fabrics/ COM	
16062/D	Grade D Fabrics	
16062/E	Grade E Fabrics/ Ultrasuede	
16062/F	Grade F Fabrics	
16062/G	Grade G Fabrics	
16062/P1	Leather 1- Serie 100/ Mastrotto Leather	

### King Size Bed w/ Upholstered Headboard

C.O.M. Requirement: 6 yards of 55" W Plain Fabric

C.O.L. Requirement: 60 sq ft

88 1/4"      59"      92"

16060/B	Grade B Fabrics/ Faux Leather	
16060/C	Grade C Fabrics/ COM	
16060/D	Grade D Fabrics	
16060/E	Grade E Fabrics/ Ultrasuede	
16060/F	Grade F Fabrics	
16060/G	Grade G Fabrics	
16060/P1	Leather 1- Serie 100/ Mastrotto Leather	

### California King Size Bed w/ Upholstered Headboard

C.O.M. Requirement: 6 yards of 55" W Plain Fabric

C.O.L. Requirement: 60 sq ft

84"      59"      96 1/4"

16061/B	Grade B Fabrics/ Faux Leather	
16061/C	Grade C Fabrics/ COM	
16061/D	Grade D Fabrics	
16061/E	Grade E Fabrics/ Ultrasuede	
16061/F	Grade F Fabrics	
16061/G	Grade G Fabrics	
16061/P1	Leather 1- Serie 100/ Mastrotto Leather	



Bedroom	Item No. Description	Dimension in inches		
		W	H	D

## Upholstered Headboard Only

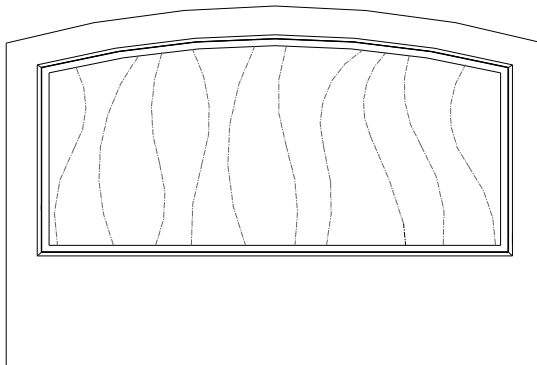

### Upcharge for Headboard LED Lights

16097	
-------	--

### Queen Size Bed w/ Upholstered Headboard

C.O.M. Requirement: 3 yards of 55" W Plain Fabric

C.O.L. Requirement: 33 sq ft

71"      59"      6 1/2"

16065/B	Grade B Fabrics/ Faux Leather	
16065/C	Grade C Fabrics/ COM	
16065/D	Grade D Fabrics	
16065/E	Grade E Fabrics/ Ultrasuede	
16065/F	Grade F Fabrics	
16065/G	Grade F Fabrics	
16065/P1	Leather 1- Serie 100/ Mastrotto Leather	

### King Size Bed w/ Upholstered Headboard

C.O.M. Requirement: 3 yards of 55" W Plain Fabric

C.O.L. Requirement: 35 sq ft

88 1/4"      59"      6 1/2"

16063/B	Grade B Fabrics/ Faux Leather	
16063/C	Grade C Fabrics/ COM	
16063/D	Grade D Fabrics	
16063/E	Grade E Fabrics/ Ultrasuede	
16063/F	Grade F Fabrics	
16063/G	Grade G Fabrics	
16063/P1	Leather 1- Serie 100/ Mastrotto Leather	

### California King Size Bed w/ Upholstered Headboard

C.O.M. Requirement: 3 yards of 55" W Plain Fabric

C.O.L. Requirement: 35 sq ft

84"      59"      6 1/2"

16064/B	Grade B Fabrics/ Faux Leather	
16064/C	Grade C Fabrics/ COM	
16064/D	Grade D Fabrics	
16064/E	Grade E Fabrics/ Ultrasuede	
16064/F	Grade F Fabrics	
16064/G	Grade G Fabrics	
16064/P1	Leather 1- Serie 100/ Mastrotto Leather	

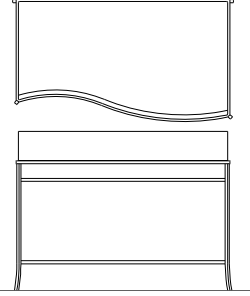
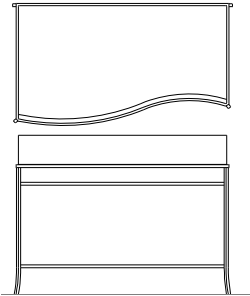
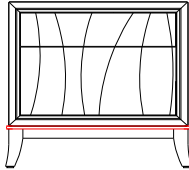
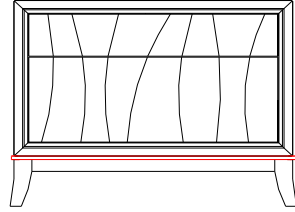
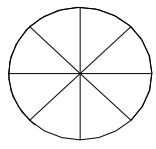
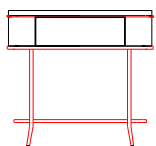
Bedroom	Item No. Description	Dimension in inches		
		W	H	D
	<b>16020</b> Left Night Stand w/ Metal Base 1 Drawer	33 7/8"	27 1/2"	17 1/4" 21"
	<b>16021</b> Right Night Stand w/ Metal Base 1 Drawer	33 7/8"	27 1/2"	17 1/4" 21"
	<b>16019</b> 2 Drawer Night Stand	27 1/2"	26 3/8"	19 1/4"
	<b>16018</b> 2 Drawer Night Stand	33"	26 3/8"	19 1/4"
 	<b>16023</b> 1 Drawer Round Night Stand	25 5/8"	25 5/8"	25 5/8"

Bedroom	Item No. Description	Dimension in inches		
		W	H	D

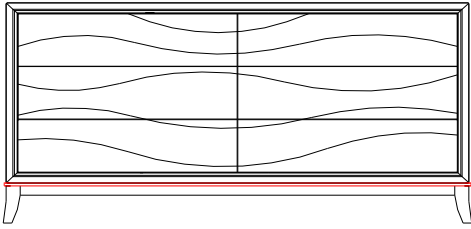

**16034**  
Triple Dresser  
6 Drawers

70"      35 5/8"      20 1/2"

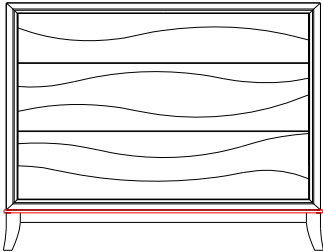

**16025**  
Single Dresser  
3 Drawers

47 5/8"      40 1/4"      19 1/4"

# Artisan II Collection

Designed By  
Berry & Clark Design Associates



## Artisan II Collection

Shaded Walnut #45 (5% Sheen)



**Please Note:** All metal accents in combination with Walnut are in Bronze color painted iron.

# Artisan II Collection

## Lacquer Finishes (50% Sheen)



AR300 White Lacquer  
(Blanco)



AR309 Basalt Lacquer  
(Basalto)



AR301 Riga Lacquer



AR310 Carriage Red Lacquer  
(Carruaje)



AR302 Colina Lacquer



AR311 Khartoum Lacquer  
(Jartum)



AR303 Gray Stone Lacquer  
(Gris Piedra)

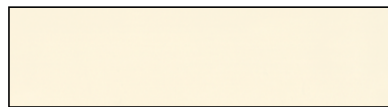

AR312 Accero Lacquer



AR304 Sputnik Lacquer

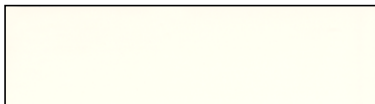

AR313 Ivory Lacquer  
(Avorio)

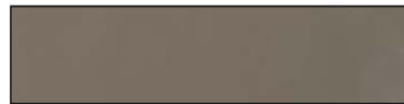

AR305 Gothic Lacquer  
(Gotico)



AR319 Stone Lacquer  
(Piedra)



AR306 Black Lacquer  
(Negro Bulgari)

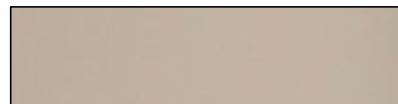

AR320 Clear Beige Lacquer  
(Beige Claro)



AR307 #9010 White Lacquer  
(9010 Blanco)

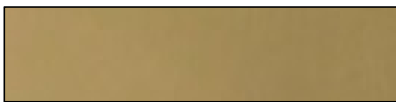

AR321 Brass Lacquer  
(Laton)



AR322 Copper Lacquer  
(Cobre)



AR308 VD115 Lacquer



Bronze Lacquer  
(Bronce)

**\*\*\* 5% UPCHARGE FOR HIGH GLOSS LACQUER\*\*\***

Dining Room	Item No. Description	Dimension in inches		
		W	H	D

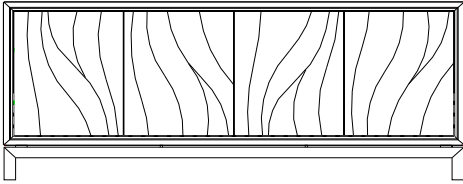

**Finish:** Walnut w/ Bronze Metal Legs

**16120**  
Credenza on Metal legs  
4 Doors  
1 Interior Drawer  
5 Adjustable Shelves

78 3/4"    33 1/2"    20 1/2"

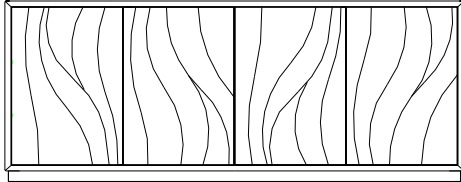
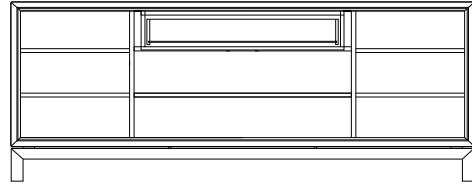

**Finish:** Walnut w/ Walnut Plinth

**16126**  
Credenza on Plinth  
4 Doors  
1 Interior Drawer  
1 Bottle Storage  
5 Adjustable Shelves

79 1/2"    35 1/2"    20 1/2"

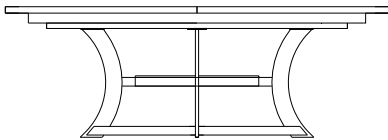
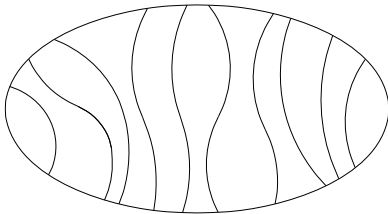
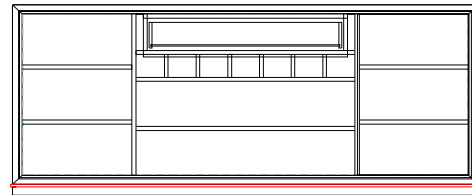

**Finish:** Walnut w/ Bronze Metal Accents

**16125**  
Oval Dining Table w/ Metal/Wood Pedestal  
1 Removable Center Extension 23 5/8" Wide  
Plain Veneer

88"    30"    54"

*Please Note: Table top cannot be done in two different finishes.  
The "two-toned" effect is achieved by altering the veneer direction.  
Painted finishes will not result in the "two-toned" effect.*

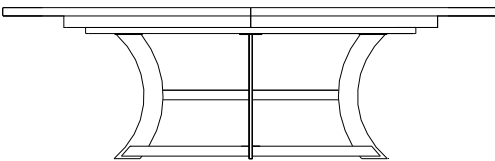
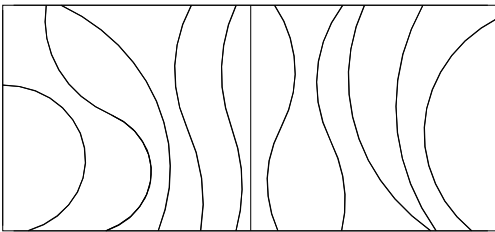

**Finish:** Walnut w/ Bronze Metal Accents

**16124**  
Rectangular Dining Table w/ Metal/Wood Pedestal  
1 Removable Center Extension 23 5/8" Wide  
Plain Veneer

90 1/2"    30"    45 1/4"

*Please Note: Table top cannot be done in two different finishes.  
The "two-toned" effect is achieved by altering the veneer direction.  
Painted finishes will not result in the "two-toned" effect.*

Dining Room	Item No. Description	Dimension in inches		
		W	H	D

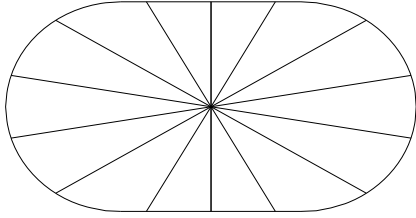

**16042** 82 1/4" 30" 46"

Race Track Oval Dining Table  
1 Removable Center Extension 23 5/8" Wide

*Please Note: Table top cannot be done in two different finishes.  
The "two-toned" effect is achieved by altering the veneer direction.  
Painted finishes will not result in the "two-toned" effect.*

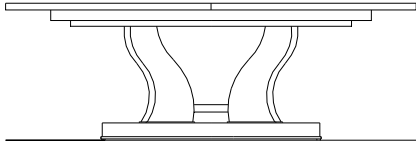

**Finish:** Walnut w/ Bronze Metal Accents

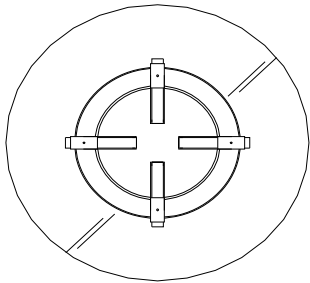

**16046** 63" 30" 63"  
Round Dining Table incl 63" diameter glass top

**16047** 59" 30" 59"  
Round Dining Table incl 59" diameter glass top

**16048** 55 1/8" 30" 55 1/8"  
Round Dining Table incl 55 1/8" diameter glass top

**16049**  
BASE ONLY for Round Dining Table

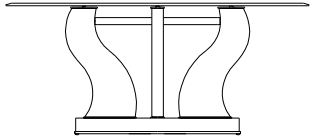

**Finish:** Walnut w/ Bronze Metal Accents

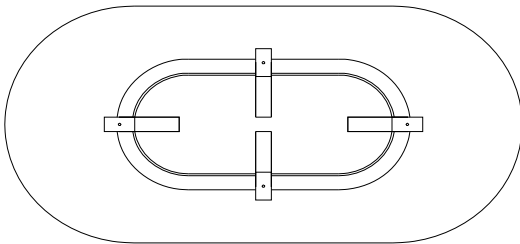

**16039** 94 1/2" 30" 47 1/4"

Oval Dining Table w/ Metal/Wood Pedestal

**16037**  
BASE ONLY for Oval Dining Table

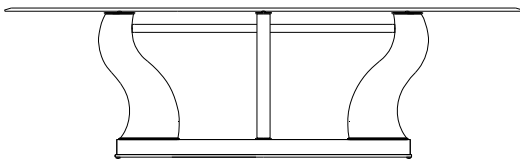

**Finish:** Walnut w/ Bronze Metal Accents



Dining Room	Item No. Description	Dimension in inches		
		W	H	D

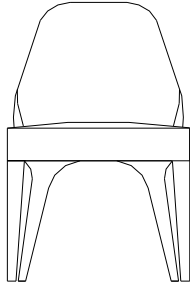
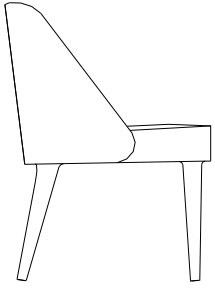

**Upholstered Dining Chair**

**C.O.M. Requirement:**  
2 1/2 yards of 55" Plain Fabric

**Upholstered Dining Chair** w/ Wooden Legs      19 7/8"      33 1/2"      22 1/2"

**16132/B**  
Faux Leather

**16132/C**  
Fabrics-Grade C/ C.O.M.

**16132/D**  
Fabrics-Grade D

**16132/E**  
Fabrics-Grade E/ Ultrasuede

**16132/P1**  
Leather Serie 100/ Mastrotto Leather

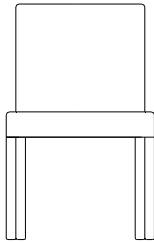
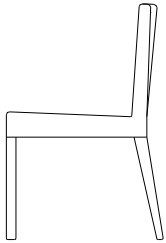

**Side Chair**

Seat Height: 17 3/4"

**C.O.M. Requirement:**  
1 1/2 yards of 55"W Plain Fabric

**Side Chair**      19 1/8"      32 1/4"      22"

**16130/B**  
Faux Leather

**16130/C**  
Fabrics-Grade C/ C.O.M.

**16130/D**  
Fabrics-Grade D

**16130/E**  
Fabrics-Grade E/ Ultrasuede

**16130/P1**  
Leather Serie 100/ Mastrotto Leather

**\*\*Legs & Arms Only Available in Lacquer Finishes; Top Rail Available in Lacquer or Walnut\*\***

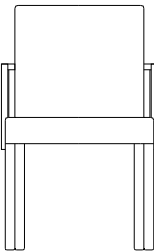
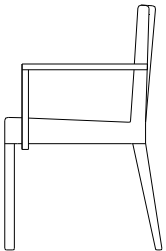

**Arm Chair**

Seat Height: 17 3/4"  
Arm Height: 25 1/4"

**C.O.M. Requirement:**  
1 1/2 yards of 55"W Plain Fabric

**Arm Chair**      21"      32 1/4"      22"

**16131/B**  
Faux Leather

**16131/C**  
Fabrics-Grade C/ C.O.M.

**16131/D**  
Fabrics-Grade D

**16131/E**  
Fabrics-Grade E/ Ultrasuede

**16131/P1**  
Leather Serie 100/ Mastrotto Leather

**\*\*Legs & Arms Only Available in Lacquer Finishes; Top Rail Available in Lacquer or Walnut\*\***

Dining Room	Item No. Description	Dimension in inches		
		W	H	D

Side Chair	19 1/8"	34 1/2"	22"
------------	---------	---------	-----

w/ Top Rail

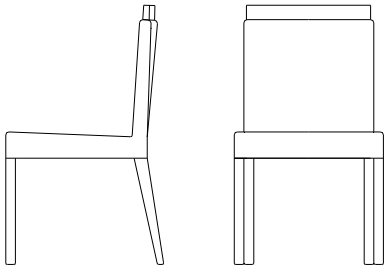

**Side Chair**

Seat Height: 17 3/4"

**C.O.M. Requirement:**

1 1/2 yards of 55"W Plain Fabric

**16133/B**  
Faux Leather

**16133/C**  
Fabrics-Grade C/ C.O.M.

**16133/D**  
Fabrics-Grade D

**16133/E**  
Fabrics-Grade E/ Ultrasuede

**16133/P1**  
Leather Serie 100/ Mastrotto Leather

**\*\*Legs & Arms Only Available in Lacquer Finishes; Top Rail Available in Lacquer or Walnut\*\***

Arm Chair	21"	34 1/2"	22"
-----------	-----	---------	-----

w/ Top Rail

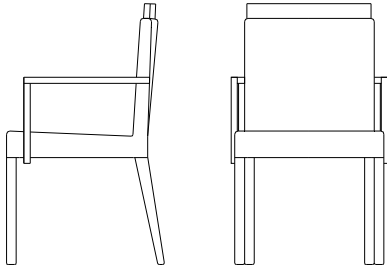

**Arm Chair**

Seat Height: 17 3/4"  
Arm Height: 25 1/4"

**C.O.M. Requirement:**

1 1/2 yards of 55"W Plain Fabric

**16134/B**  
Faux Leather

**16134/C**  
Fabrics-Grade C/ C.O.M.

**16134/D**  
Fabrics-Grade D

**16134/E**  
Fabrics-Grade E/ Ultrasuede

**16134/P1**  
Leather Serie 100/ Mastrotto Leather

**\*\*Legs & Arms Only Available in Lacquer Finishes; Top Rail Available in Lacquer or Walnut\*\***

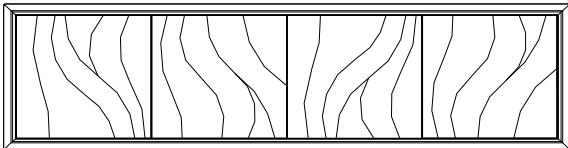

16121	78 3/4"	22 1/4"	17"
-------	---------	---------	-----

Wall Mounted Unit

w/ 4 interior drawers & 2 shelves behind center doors

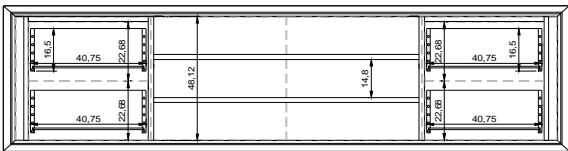

## Curio & Storage Cabinets

Item No. Description	Dimension in inches		
	W	H	D

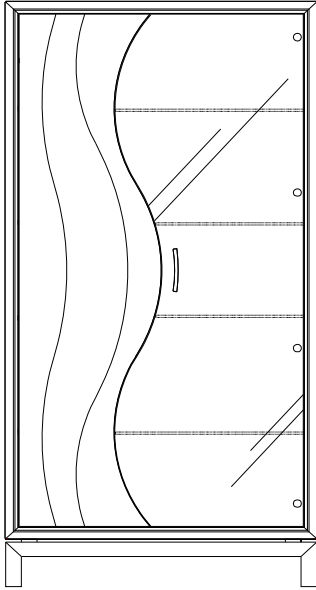

**16122 (LEFT)**                      39 3/4"              80 3/4"              19 5/8"  
 Curio Showcase on Metal Legs  
 2 Interior Drawers behind Wooden Door

**16123 (RIGHT)**                      39 3/4"              80 3/4"              19 5/8"  
 Curio Showcase on Metal Legs  
 2 Interior Drawers behind Wooden Door

**16004**  
 Upcharge for LED Lights

**Finish:** Walnut w/ Bronze Metal Legs

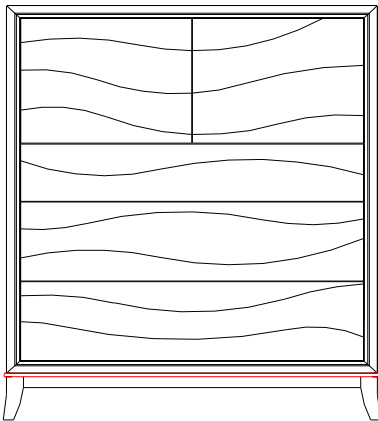

**16009**                                      47 1/2"              57 1/2"              19 1/4"  
 Chest w/ doors & 3 drawers

**Finish:** Walnut w/ Walnut Legs

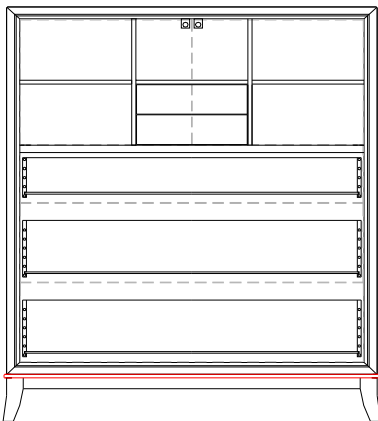

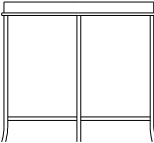
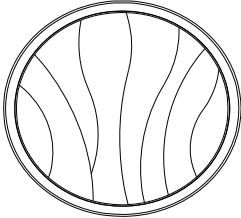
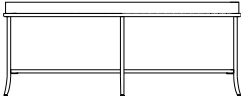
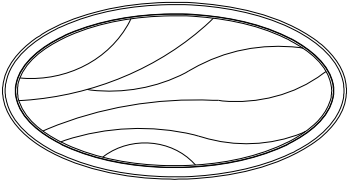
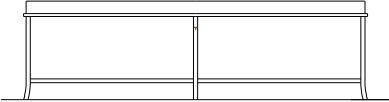
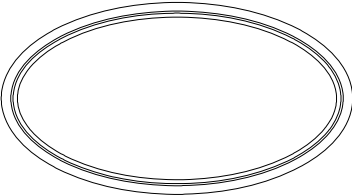
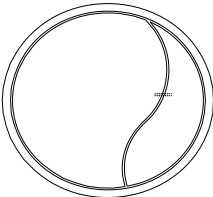
Occasional	Item No. Description	Dimension in inches		
		W	H	D
	<b>16142</b> Round Lamp Table w/ Bronze Metal Base	25 3/4"	26"	25 3/4"
				
	<b>16141</b> Round Cocktail Table w/ Bronze Metal Base	39 3/8"	17"	39 3/8"
				
	<b>16140</b> Oval Cocktail Table w/ Bronze Metal Base	50 3/4"	17"	28 3/4"
				
	<b>16071</b> Oval Mirror <b>Finish:</b> Walnut w/ Bronze Metal Accents	60"	36"	2"
	<b>16073</b> Round Mirror <b>Finish:</b> Walnut w/ Bronze Metal Accents	39 3/8"	39 3/8"	2"

Home Office	Item No. Description	Dimension in inches		
		W	H	D

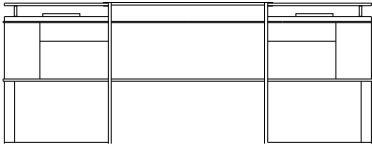
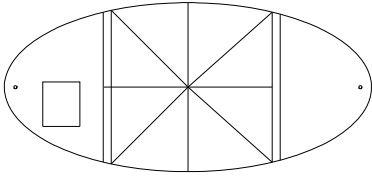

**16076**                      73 5/8"        30 1/8"        37"

Oval Desk w/ Metal Legs  
w/ two 2 drawer pedestals  
Glass Ends

**Finish:** Walnut w/ Bronze Metal Accents

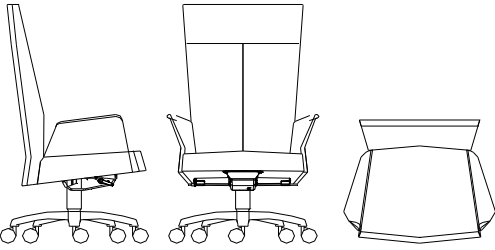

C.O.M. Requirement: 3 1/2 yards of 55"W Plain Fabric  
C.O.L. Requirement: 52 Sq Ft

**Executive Chair**                      31 1/2        47 1/4        26 3/4

<b>8722/B</b>	Fabric-Grade B/ Faux Leather	
<b>8722/C</b>	Fabric-Grade C/C.O.M	
<b>8722/D</b>	Fabric-Grade D	
<b>8722/E</b>	Fabric-Grade E/ Ultra suede	
<b>8722/F</b>	Fabric-Grade F	
<b>8722/G</b>	Fabric-Grade G	
<b>8722/P1</b>	Leather Serie 100/ Mastrotto Leather	

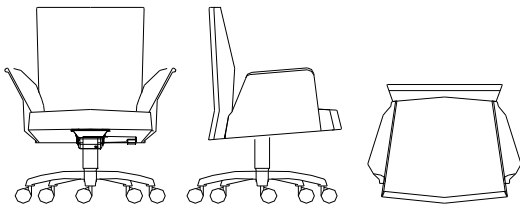

C.O.M. Requirement: 3 1/2 yards of 55"W Plain Fabric  
C.O.L. Requirement: 52 Sq Ft

**Desk Chair**                      31 1/2        33 1/2        26 3/4

<b>11594/B</b>	Fabric-Grade B/ Faux Leather	
<b>11594/C</b>	Fabric-Grade C/C.O.M	
<b>11594/D</b>	Fabric-Grade D	
<b>11594/E</b>	Fabric-Grade E/ Ultra suede	
<b>11594/F</b>	Fabric-Grade F	
<b>11594/G</b>	Fabric-Grade G	
<b>11594/P1</b>	Leather Serie 100/ Mastrotto Leather	

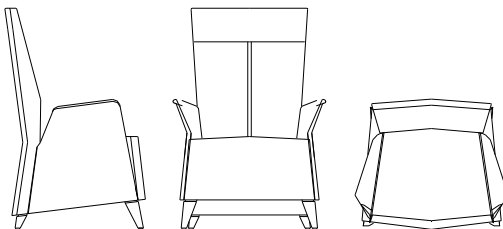

C.O.M. Requirement: 4 yards of 55"W Plain Fabric  
C.O.L. Requirement: 65 Sq Ft

**Guest Armchair**                      32 1/4        44        26 3/4

<b>8720/B</b>	Fabric-Grade B/ Faux Leather	
<b>8720/C</b>	Fabric-Grade C/C.O.M	
<b>8720/D</b>	Fabric-Grade D	
<b>8720/E</b>	Fabric-Grade E/ Ultra suede	
<b>8720/F</b>	Fabric-Grade F	
<b>8720/G</b>	Fabric-Grade G	
<b>8720/P1</b>	Leather Serie 100/ Mastrotto Leather	

<b>Bedroom</b>	<b>Item No.</b>	<b>Dimension in inches</b>		
	<b>Description</b>	<b>W</b>	<b>H</b>	<b>D</b>

## Panel Beds in Walnut w/ Bronze Metal Accents

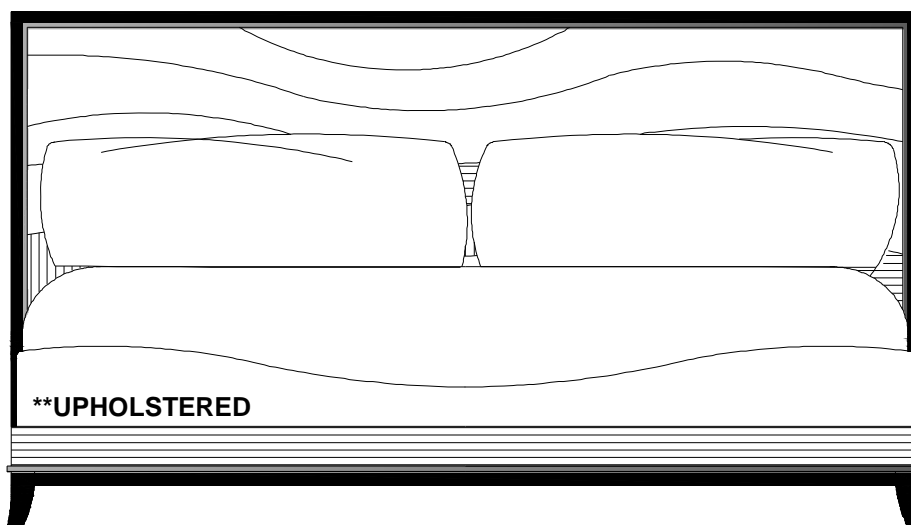

**C.O.M REQUIREMENT FOR ALL SIZES: 2 1/2 YARDS OF 55"W PLAIN FABRIC**

### Queen Size Panel Bed

65 1/2"      52 1/4"      85 3/8"

<b>16103/B</b>	Fabric-Grade B/ Faux Leather	
<b>16103/C</b>	Grade C Fabrics/ COM	
<b>16103/D</b>	Grade D Fabrics	
<b>16103/E</b>	Grade E Fabrics/ Ultrasuede	
<b>16103/F</b>	Grade F Fabrics	
<b>16103/G</b>	Grade G Fabrics	
<b>16103/P1</b>	Leather 1- Serie 100/ Mastrotto Leather	

### King Size Panel Bed

81 1/2"      52 1/4"      85 3/8"

<b>16104/B</b>	Fabric-Grade B/ Faux Leather	
<b>16104/C</b>	Grade C Fabrics/ COM	
<b>16104/D</b>	Grade D Fabrics	
<b>16104/E</b>	Grade E Fabrics/ Ultrasuede	
<b>16104/F</b>	Grade F Fabrics	
<b>16104/G</b>	Grade G Fabrics	
<b>16104/P1</b>	Leather 1- Serie 100/ Mastrotto Leather	

### California King Size Panel Bed

77 1/2"      52 1/4"      89 1/4"

<b>16105/B</b>	Fabric-Grade B/ Faux Leather	
<b>16105/C</b>	Grade C Fabrics/ COM	
<b>16105/D</b>	Grade D Fabrics	
<b>16105/E</b>	Grade E Fabrics/ Ultrasuede	
<b>16105/F</b>	Grade F Fabrics	
<b>16105/G</b>	Grade G Fabrics	
<b>16105/P1</b>	Leather 1- Serie 100/ Mastrotto Leather	

Bedroom	Item No. Description	Dimension in inches		
		W	H	D

**Panel Headboards Only in Walnut w/ Bronze Metal Accents**

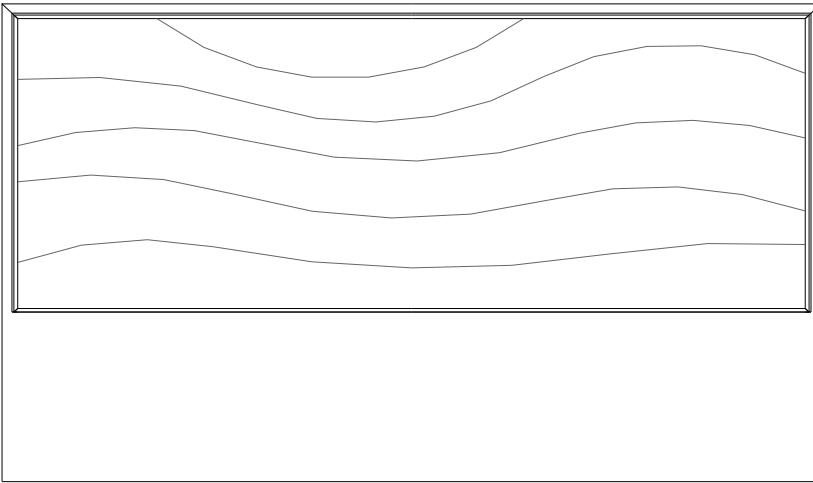

**Queen Size Panel Bed ( Headboard ONLY)**

65 1/2"      52 1/4"      2"

16109	
-------	--

**King Size Panel Bed ( Headboard ONLY)**

81 1/2"      52 1/4"      2"

16110	
-------	--

**California King Size Panel Bed ( Headboard ONLY)**

77 1/2"      52 1/4"      2"

16111	
-------	--

Bedroom	Item No. Description	Dimension in inches		
		W	H	D

**Bed w/ Upholstered Headboard & Upper Bed Frame in Walnut w/ Bronze Metal Accents**

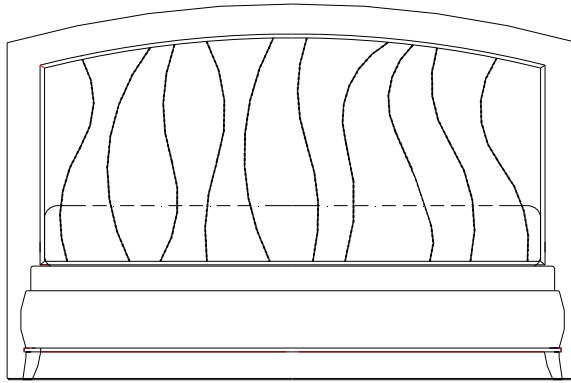

**Upcharge for Headboard LED Lights**

<b>16097</b>	
--------------	--

**Queen Size Bed w/ Upholstered Headboard**

C.O.M. Requirement: 5 yards of 55" W Plain Fabric

C.O.L. Requirement: 54 sq ft

71"      59"      92"

<b>16115/B</b>	Grade B Fabrics/ Faux Leather	
<b>16115/C</b>	Grade C Fabrics/ COM	
<b>16115/D</b>	Grade D Fabrics	
<b>16115/E</b>	Grade E Fabrics/ Ultrasuede	
<b>16115/F</b>	Grade F Fabrics	
<b>16115/G</b>	Grade G Fabrics	
<b>16115/P1</b>	Leather 1- Serie 100/ Mastrotto Leather	

**King Size Bed w/ Upholstered Headboard**

C.O.M. Requirement: 6 yards of 55" W Plain Fabric

C.O.L. Requirement: 60 sq ft

88 1/4"      59"      92"

<b>16116/B</b>	Grade B Fabrics/ Faux Leather	
<b>16116/C</b>	Grade C Fabrics/ COM	
<b>16116/D</b>	Grade D Fabrics	
<b>16116/E</b>	Grade E Fabrics/ Ultrasuede	
<b>16116/F</b>	Grade F Fabrics	
<b>16116/G</b>	Grade G Fabrics	
<b>16116/P1</b>	Leather 1- Serie 100/ Mastrotto Leather	

**California King Size Bed w/ Upholstered Headboard**

C.O.M. Requirement: 6 yards of 55" W Plain Fabric

C.O.L. Requirement: 60 sq ft

84"      59"      96 1/4"

<b>16117/B</b>	Grade B Fabrics/ Faux Leather	
<b>16117/C</b>	Grade C Fabrics/ COM	
<b>16117/D</b>	Grade D Fabrics	
<b>16117/E</b>	Grade E Fabrics/ Ultrasuede	
<b>16117/F</b>	Grade F Fabrics	
<b>16117/G</b>	Grade G Fabrics	
<b>16117/P1</b>	Leather 1- Serie 100/ Mastrotto Leather	



Bedroom	Item No. Description	Dimension in inches		
		W	H	D

## Upholstered Headboard Only in Walnut w/ Bronze Metal Accents

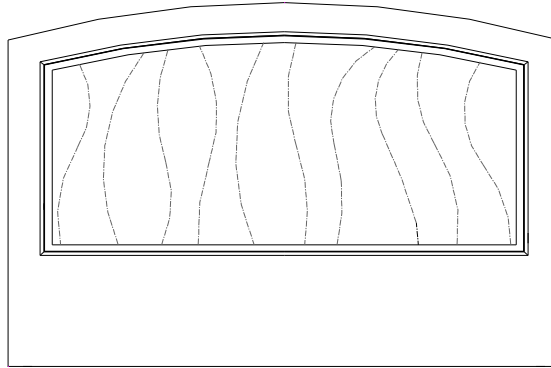

### Upcharge for Headboard LED Lights

16097	
-------	--

### Queen Size Bed w/ Upholstered Headboard

C.O.M. Requirement: 3 yards of 55" W Plain Fabric

C.O.L. Requirement: 33 sq ft

71"      59"      6 1/2"

16153/B	Grade B Fabrics/ Faux Leather	
16153/C	Grade C Fabrics/ COM	
16153/D	Grade D Fabrics	
16153/E	Grade E Fabrics/ Ultrasuede	
16153/F	Grade F Fabrics	
16153/G	Grade F Fabrics	
16153/P1	Leather 1- Serie 100/ Mastrotto Leather	

### King Size Bed w/ Upholstered Headboard

C.O.M. Requirement: 3 yards of 55" W Plain Fabric

C.O.L. Requirement: 35 sq ft

88 1/4"      59"      6 1/2"

16154/B	Grade B Fabrics/ Faux Leather	
16154/C	Grade C Fabrics/ COM	
16154/D	Grade D Fabrics	
16154/E	Grade E Fabrics/ Ultrasuede	
16154/F	Grade F Fabrics	
16154/G	Grade G Fabrics	
16154/P1	Leather 1- Serie 100/ Mastrotto Leather	

### California King Size Bed w/ Upholstered Headboard

C.O.M. Requirement: 3 yards of 55" W Plain Fabric

C.O.L. Requirement: 35 sq ft

84"      59"      6 1/2"

16155/B	Grade B Fabrics/ Faux Leather	
16155/C	Grade C Fabrics/ COM	
16155/D	Grade D Fabrics	
16155/E	Grade E Fabrics/ Ultrasuede	
16155/F	Grade F Fabrics	
16155/G	Grade G Fabrics	
16155/P1	Leather 1- Serie 100/ Mastrotto Leather	

Bedroom	Item No. Description	Dimension in inches		
		W	H	D

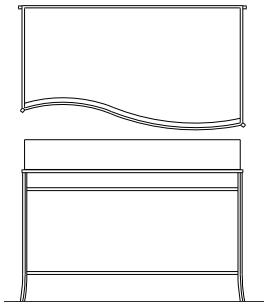

**16014** 34" 27 1/2" 17 1/4"  
21"  
Left Night Stand w/ Bronze Metal Base  
1 Drawer

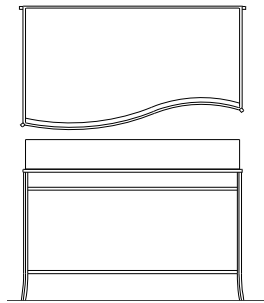

**16013** 34" 27 1/2" 17 1/4"  
21"  
Right Night Stand w/ Bronze Metal Base  
1 Drawer

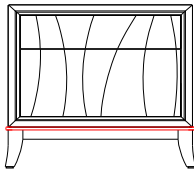

**16015** 27 1/2" 26 3/8" 19 1/4"  
2 Drawer Night Stand w/ Walnut Legs

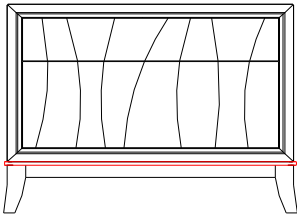

**16016** 33" 26 3/8" 19 1/4"  
2 Drawer Night Stand w/ Walnut Legs

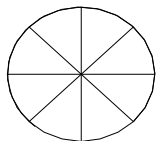

**16011** 25 5/8" 25 5/8" 25 5/8"  
1 Drawer Round Night Stand w/ Bronze Metal Base

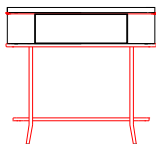

Bedroom	Item No. Description	Dimension in inches		
		W	H	D

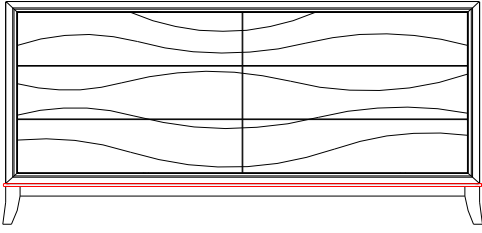

**16007**

70"

35 5/8"

20 1/2"

Triple Dresser  
6 Drawers

**Finish:** Walnut w/ Walnut Legs

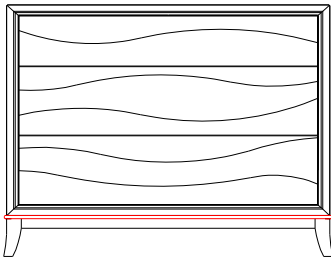

**16017**

47 5/8"

40 1/4"

19 1/4"

Single Dresser  
3 Drawers

**Finish:** Walnut w/ Walnut Legs