

# PLANUM LEATHER COLLECTION

by

**KELVIN GIORMANI**

**BOOK 1A**



Chairs and Chaises

Ottomans

Throw Pillows

**PLANUM**<sup>®</sup>  
F U R N I T U R E

Planum, Inc  
Swedesford Corporate Center  
619 B Swedesford Road  
Frazer, PA 19355

email [info@planumfurniture.com](mailto:info@planumfurniture.com)  
visit us [planumfurniture.com](http://planumfurniture.com)

Tel : 610/251-2120  
Tel : 800/343-0042  
Fax : 610/251-2290

## Table of Contents

|                    | Page |
|--------------------|------|
| Chairs and Chaises | 3    |
| Ottoman            | 51   |
| Throw Pillows      | 52   |
| Leather Warranty   | 53   |

# PLANUM LEATHER

## Model 0038 Embrace



| Model No. | Item No. | Dimensions | Retail  |                               |                                    |       |
|-----------|----------|------------|---------|-------------------------------|------------------------------------|-------|
|           |          |            | B       | C                             | D                                  | E     |
|           |          |            | Orvieto | EuroSoft/<br>Marmo/<br>Spesso | King/ Mastrotto/<br>Ricco/ Vintage | Marco |

**0038 C1DV Swivel Chair**

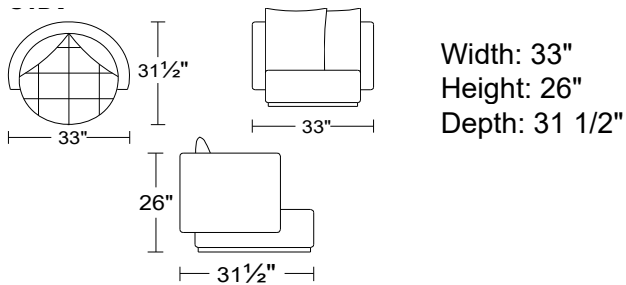

**0038 C1.5DV Swivel Chair**

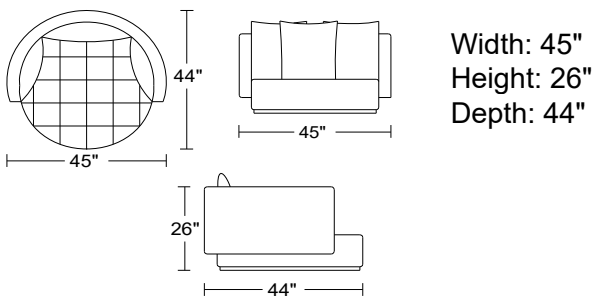

# PLANUM LEATHER

## Model 2598 Zephyr



| Model No. | Item No. | Dimensions | Retail  |                               |                                    |       |
|-----------|----------|------------|---------|-------------------------------|------------------------------------|-------|
|           |          |            | B       | C                             | D                                  | E     |
|           |          |            | Orvieto | EuroSoft/<br>Marmo/<br>Spesso | King/ Mastrotto/<br>Ricco/ Vintage | Marco |

**2598**      **18**      **Chair**

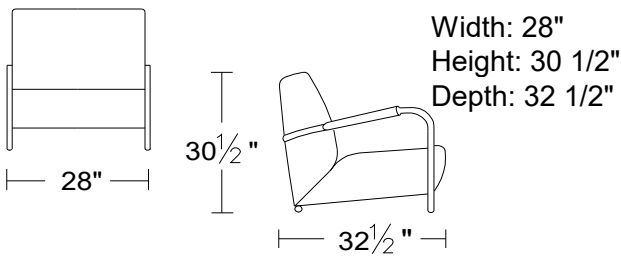

**2598**      **50**      **Ottoman**

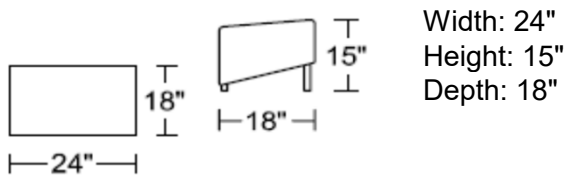

# PLANUM LEATHER

## Model 2546 Ribbon



| Model No. | Item No. | Dimensions | Retail  |                               |                                    |       |
|-----------|----------|------------|---------|-------------------------------|------------------------------------|-------|
|           |          |            | B       | C                             | D                                  | E     |
|           |          |            | Orvieto | EuroSoft/<br>Marmo/<br>Spesso | King/ Mastrotto/<br>Ricco/ Vintage | Marco |

2546

18

Chaise

Width: 28 1/2"

Height: 34"

Depth: 73 1/2"

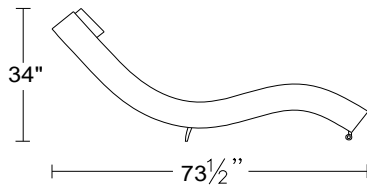
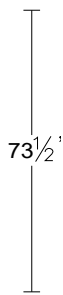
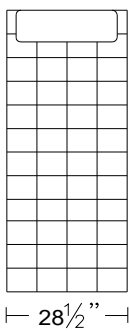

# PLANUM LEATHER

## Model LC03 Verona



| Model No. | Item No. | Dimensions | Retail  |                               |                                    |       |
|-----------|----------|------------|---------|-------------------------------|------------------------------------|-------|
|           |          |            | B       | C                             | D                                  | E     |
|           |          |            | Orvieto | EuroSoft/<br>Marmo/<br>Spesso | King/ Mastrotto/<br>Ricco/ Vintage | Marco |

LC03

18

Swivel Chaise

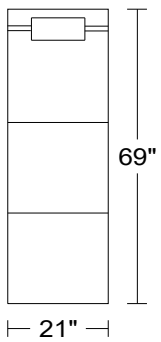

Width: 21"  
Height: 33"  
Depth: 69"

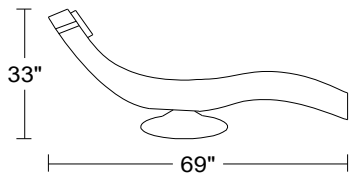

# PLANUM LEATHER

## Model AC07 Scoop



| Model No. | Item No. | Dimensions | Retail  |                               |                                    |       |
|-----------|----------|------------|---------|-------------------------------|------------------------------------|-------|
|           |          |            | B       | C                             | D                                  | E     |
|           |          |            | Orvieto | EuroSoft/<br>Marmo/<br>Spesso | King/ Mastrotto/<br>Ricco/ Vintage | Marco |

AC07

1DV

Swivel Chair

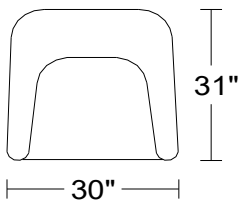

Width: 30"  
Height: 29 1/2"  
Depth: 31"

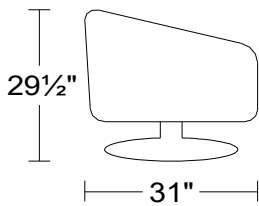

# PLANUM LEATHER

## Model AC10 Solo



| Model No. | Item No. | Dimensions | Retail  |                               |                                    |       |
|-----------|----------|------------|---------|-------------------------------|------------------------------------|-------|
|           |          |            | B       | C                             | D                                  | E     |
|           |          |            | Orvieto | EuroSoft/<br>Marmo/<br>Spesso | King/ Mastrotto/<br>Ricco/ Vintage | Marco |

**AC10**

**1DV**

**Swivel Chair**

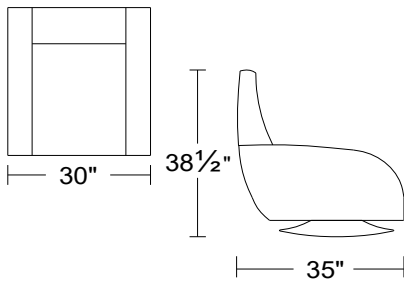

Width: 30"  
Height: 38 1/2"  
Depth: 35"

**AC10**

**STV**

**Swivel Ottoman**

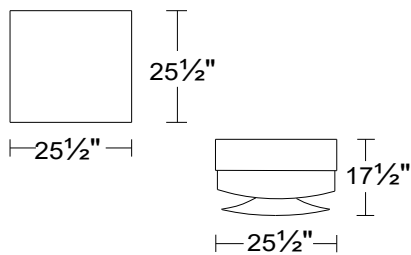

Width: 25 1/2"  
Height: 17 1/2"  
Depth: 25 1/2"



# PLANUM LEATHER

## Model AC19 Intrigue



| Model No. | Item No. | Dimensions | Retail  |                               |                                    |       |
|-----------|----------|------------|---------|-------------------------------|------------------------------------|-------|
|           |          |            | B       | C                             | D                                  | E     |
|           |          |            | Orvieto | EuroSoft/<br>Marmo/<br>Spesso | King/ Mastrotto/<br>Ricco/ Vintage | Marco |

**AC19**

**1D**

**Chair**

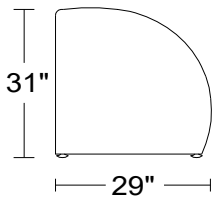
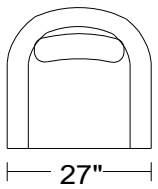

Width: 27"  
Height: 31"  
Depth: 29"

**AC19**

**ST**

**Ottoman**

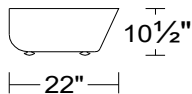
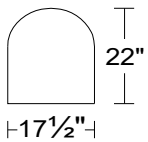

Width: 17 1/2"  
Height: 10 1/2"  
Depth: 22"

# PLANUM LEATHER

## Model AC20 Dorn



| Model No. | Item No. | Dimensions   | Retail  |                               |                                    |       |
|-----------|----------|--------------|---------|-------------------------------|------------------------------------|-------|
|           |          |              | B       | C                             | D                                  | E     |
|           |          |              | Orvieto | EuroSoft/<br>Marmo/<br>Spesso | King/ Mastrotto/<br>Ricco/ Vintage | Marco |
| AC20      | 1DV      | Swivel Chair |         |                               |                                    |       |

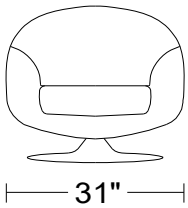

Width: 31"  
Height: 30"  
Depth: 34"

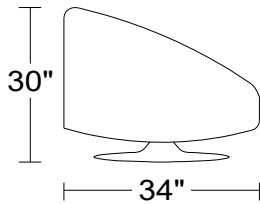

# PLANUM LEATHER

Model AC24 V.S.O.P



| Model No. | Item No. | Dimensions | Retail  |                               |                                    |       |
|-----------|----------|------------|---------|-------------------------------|------------------------------------|-------|
|           |          |            | B       | C                             | D                                  | E     |
|           |          |            | Orvieto | EuroSoft/<br>Marmo/<br>Spesso | King/ Mastrotto/<br>Ricco/ Vintage | Marco |

AC24

1DV

Swivel Chair

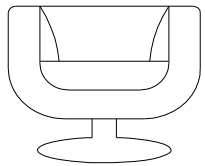

Width: 31"  
Height: 28"  
Depth: 30 1/2"

31"

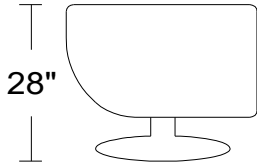

28"

30 1/2"

# PLANUM LEATHER

## Model AC25 Loft



| Model No. | Item No. | Dimensions | Retail  |                               |                                    |       |
|-----------|----------|------------|---------|-------------------------------|------------------------------------|-------|
|           |          |            | B       | C                             | D                                  | E     |
|           |          |            | Orvieto | EuroSoft/<br>Marmo/<br>Spesso | King/ Mastrotto/<br>Ricco/ Vintage | Marco |

AC25

1D

Chair

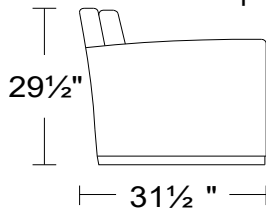
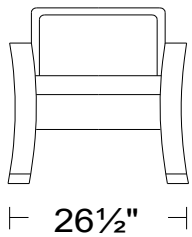

Width: 26 1/2"  
Height: 29 1/2"  
Depth: 31 1/2"

# PLANUM LEATHER

## Model AC30 Hecken



| Model No. | Item No. | Dimensions | Retail  |                               |                                    |       |
|-----------|----------|------------|---------|-------------------------------|------------------------------------|-------|
|           |          |            | B       | C                             | D                                  | E     |
|           |          |            | Orvieto | EuroSoft/<br>Marmo/<br>Spesso | King/ Mastrotto/<br>Ricco/ Vintage | Marco |

AC30

1DV

Swivel Chair

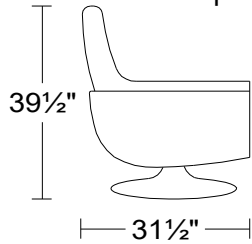
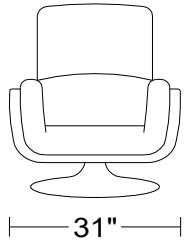

Width: 31"  
Height: 39 1/2"  
Depth: 31 1/2"

# PLANUM LEATHER

## Model AC36 Enego II



| Model No. | Item No. | Dimensions | Retail  |                               |                                    |       |
|-----------|----------|------------|---------|-------------------------------|------------------------------------|-------|
|           |          |            | B       | C                             | D                                  | E     |
|           |          |            | Orvieto | EuroSoft/<br>Marmo/<br>Spesso | King/ Mastrotto/<br>Ricco/ Vintage | Marco |

AC36

1DV

Swivel Chair

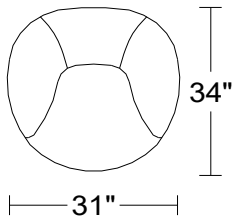

Width: 31"  
Height: 30"  
Depth: 34"

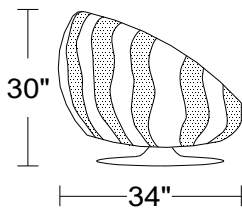

# PLANUM LEATHER

## Model AC42 Alviano



| Model No. | Item No. | Dimensions | Retail  |                               |                                    |       |
|-----------|----------|------------|---------|-------------------------------|------------------------------------|-------|
|           |          |            | B       | C                             | D                                  | E     |
|           |          |            | Orvieto | EuroSoft/<br>Marmo/<br>Spesso | King/ Mastrotto/<br>Ricco/ Vintage | Marco |

AC42

1DV

Swivel Chair

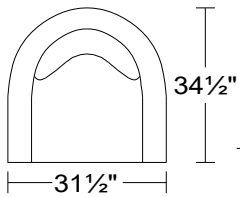

Width: 31 1/2"  
Height: 31"  
Depth: 34 1/2"

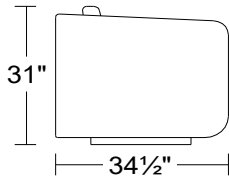

# PLANUM LEATHER

## Model AC43 Riano



| Model No. | Item No. | Dimensions | Retail  |                               |                                    |       |
|-----------|----------|------------|---------|-------------------------------|------------------------------------|-------|
|           |          |            | B       | C                             | D                                  | E     |
|           |          |            | Orvieto | EuroSoft/<br>Marmo/<br>Spesso | King/ Mastrotto/<br>Ricco/ Vintage | Marco |

AC43

1DV

Swivel Chair

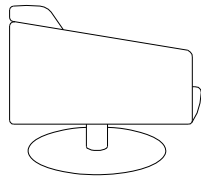
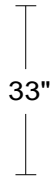
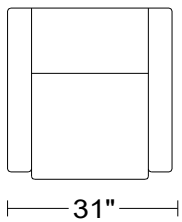

Width: 31"  
Height: 33"  
Depth: 36"



# PLANUM LEATHER

## Model AC44 Miceli



| Model No. | Item No. | Dimensions   | Retail  |                               |                                    |       |
|-----------|----------|--------------|---------|-------------------------------|------------------------------------|-------|
|           |          |              | B       | C                             | D                                  | E     |
|           |          |              | Orvieto | EuroSoft/<br>Marmo/<br>Spesso | King/ Mastrotto/<br>Ricco/ Vintage | Marco |
| AC44      | 1DV      | Swivel Chair |         |                               |                                    |       |

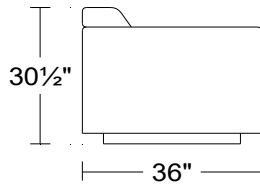
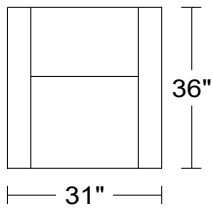

Width: 31"  
Height: 30 1/2"  
Depth: 36"

# PLANUM LEATHER

## Model AC51 Dante



| Model No. | Item No. | Dimensions | Retail  |                               |                                    |       |
|-----------|----------|------------|---------|-------------------------------|------------------------------------|-------|
|           |          |            | B       | C                             | D                                  | E     |
|           |          |            | Orvieto | EuroSoft/<br>Marmo/<br>Spesso | King/ Mastrotto/<br>Ricco/ Vintage | Marco |

**AC51**

**1DV**

**Swivel Chair**

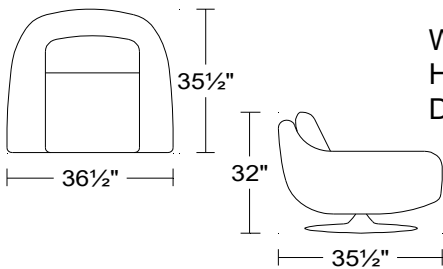

Width: 36"  
Height: 32"  
Depth: 35 1/2"

**AC51**

**STV**

**Swivel Ottoman**

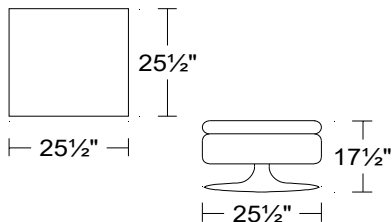

Width: 25 1/2"  
Height: 17 1/2"  
Depth: 25 1/2"

# PLANUM LEATHER

## Model AC59 Rio Roto



| Model No. | Item No. | Dimensions | Retail  |                               |                                    |       |
|-----------|----------|------------|---------|-------------------------------|------------------------------------|-------|
|           |          |            | B       | C                             | D                                  | E     |
|           |          |            | Orvieto | EuroSoft/<br>Marmo/<br>Spesso | King/ Mastrotto/<br>Ricco/ Vintage | Marco |

**AC59**

**1DV**

**Swivel Chair**

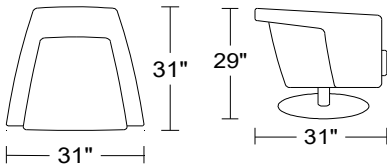

Width: 31"  
Height: 29"  
Depth: 31"

**AC59**

**1DVP**

**Swivel Chair**

w/ Perforations on recessed back & side panels

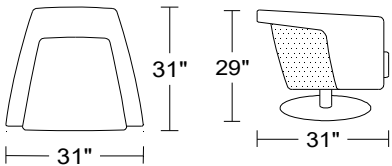

Width: 31"  
Height: 29"  
Depth: 31"

**AC59**

**STV**

**Swivel Ottoman**

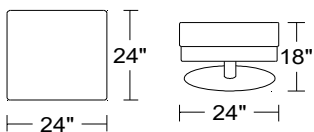

Width: 24"  
Height: 18"  
Depth: 24"

# PLANUM LEATHER

## Model AC60 Rio



| Model No. | Item No. | Dimensions | Retail  |                               |                                    |       |
|-----------|----------|------------|---------|-------------------------------|------------------------------------|-------|
|           |          |            | B       | C                             | D                                  | E     |
|           |          |            | Orvieto | EuroSoft/<br>Marmo/<br>Spesso | King/ Mastrotto/<br>Ricco/ Vintage | Marco |

**AC60**

**1D**

**Chair**

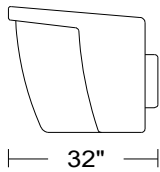
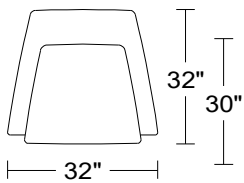

Width: 32"  
Height: 30"  
Depth: 32"

**1DV**

**Swivel Chair**

**AC60**

**1DP**

**Chair**

w/ Perforations on recessed back & side panels

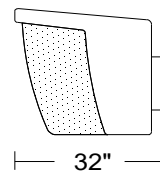
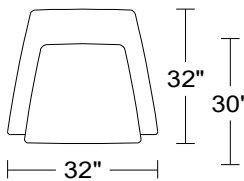

Width: 32"  
Height: 30"  
Depth: 32"

**1DVP**

**Swivel Chair**

w/ Perforations on recessed back & side panels

# PLANUM LEATHER

## Model AC61 Phoenix



| Model No. | Item No. | Dimensions | Retail  |                               |                                    |       |
|-----------|----------|------------|---------|-------------------------------|------------------------------------|-------|
|           |          |            | B       | C                             | D                                  | E     |
|           |          |            | Orvieto | EuroSoft/<br>Marmo/<br>Spesso | King/ Mastrotto/<br>Ricco/ Vintage | Marco |

**AC61**

**1DV**

**Swivel Chair**

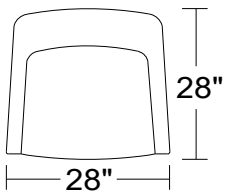

Width: 28"  
Height: 30"  
Depth: 28"

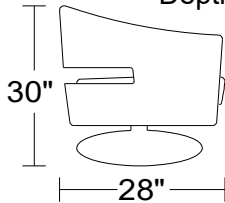

**AC61**

**STV**

**Swivel Ottoman**

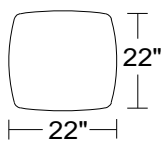

Width: 22"  
Height: 17 1/2"  
Depth: 22"

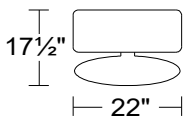

# PLANUM LEATHER

## Model AC62 Taos



| Model No. | Item No. | Dimensions | Retail  |                               |                                    |       |
|-----------|----------|------------|---------|-------------------------------|------------------------------------|-------|
|           |          |            | B       | C                             | D                                  | E     |
|           |          |            | Orvieto | EuroSoft/<br>Marmo/<br>Spesso | King/ Mastrotto/<br>Ricco/ Vintage | Marco |

**AC62**      **1D**      **Chair**

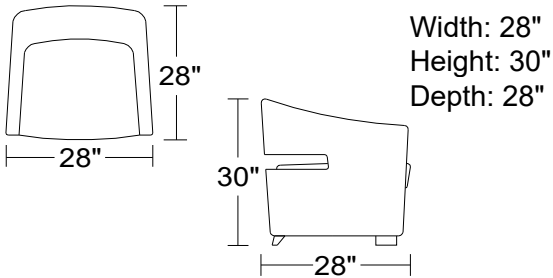

**AC62**      **ST**      **Ottoman**

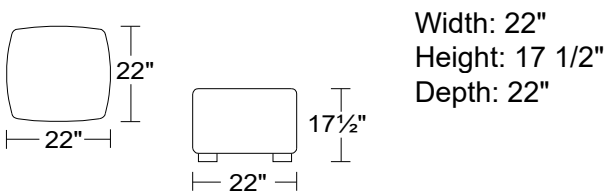

# PLANUM LEATHER

## Model AC65 Asti



| Model No. | Item No. | Dimensions | Retail  |                               |                                    |       |
|-----------|----------|------------|---------|-------------------------------|------------------------------------|-------|
|           |          |            | B       | C                             | D                                  | E     |
|           |          |            | Orvieto | EuroSoft/<br>Marmo/<br>Spesso | King/ Mastrotto/<br>Ricco/ Vintage | Marco |

**AC65**

**1DV**

**Swivel Chair**

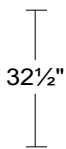
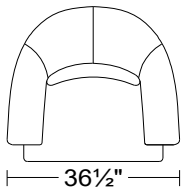

Width: 36 1/2"  
Height: 32 1/2"  
Depth: 35"

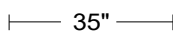

**AC65**

**1D**

**Chair**

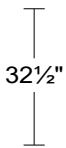
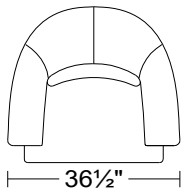

Width: 36 1/2"  
Height: 32 1/2"  
Depth: 35"

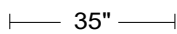

# PLANUM LEATHER

## Model AC68 Noceto



| Model No. | Item No. | Dimensions | Retail  |                               |                                    |       |
|-----------|----------|------------|---------|-------------------------------|------------------------------------|-------|
|           |          |            | B       | C                             | D                                  | E     |
|           |          |            | Orvieto | EuroSoft/<br>Marmo/<br>Spesso | King/ Mastrotto/<br>Ricco/ Vintage | Marco |

**AC68**

**1DV**

**Swivel Chair**

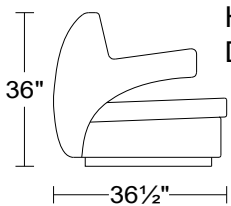
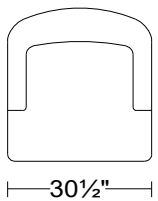

Width: 30 1/2"  
Height: 36"  
Depth: 36 1/2"

**AC68**

**1D**

**Chair**

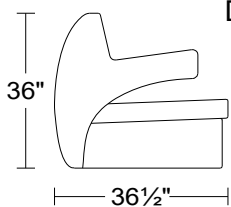
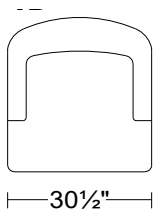

Width: 30 1/2"  
Height: 36"  
Depth: 36 1/2"



# PLANUM LEATHER

## Model AC69 Rosse II



| Model No. | Item No. | Dimensions | Retail  |                               |                                    |       |
|-----------|----------|------------|---------|-------------------------------|------------------------------------|-------|
|           |          |            | B       | C                             | D                                  | E     |
|           |          |            | Orvieto | EuroSoft/<br>Marmo/<br>Spesso | King/ Mastrotto/<br>Ricco/ Vintage | Marco |

AC69

1D

Chair

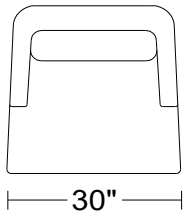

31"

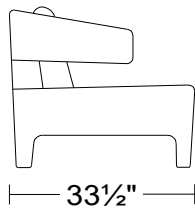

Width: 30"  
Height: 31"  
Depth: 33 1/2"

# PLANUM LEATHER

## Model AC72 Riano II



| Model No. | Item No. | Dimensions | Retail  |                               |                                    |       |
|-----------|----------|------------|---------|-------------------------------|------------------------------------|-------|
|           |          |            | B       | C                             | D                                  | E     |
|           |          |            | Orvieto | EuroSoft/<br>Marmo/<br>Spesso | King/ Mastrotto/<br>Ricco/ Vintage | Marco |

AC72

1DV

Swivel Chair

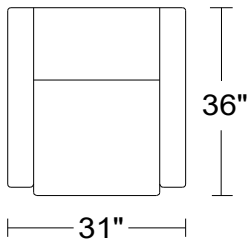

Width: 31"  
Height: 33"  
Depth: 36"

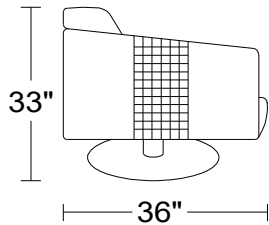

# PLANUM LEATHER

## Model C073 Brooke I



| Model No. | Item No. | Dimensions | Retail  |                               |                                    |       |
|-----------|----------|------------|---------|-------------------------------|------------------------------------|-------|
|           |          |            | B       | C                             | D                                  | E     |
|           |          |            | Orvieto | EuroSoft/<br>Marmo/<br>Spesso | King/ Mastrotto/<br>Ricco/ Vintage | Marco |

**C073**      **1DV**      **Swivel Chair**

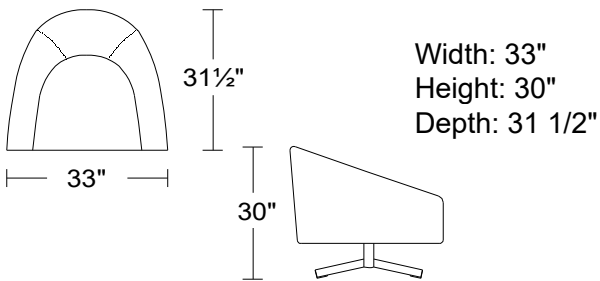

**AC73**      **STV**      **Swivel Ottoman**

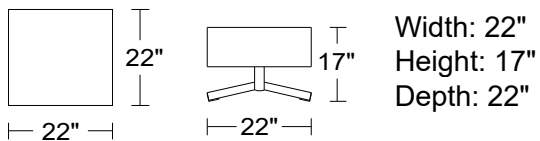

# PLANUM LEATHER

## Model AC74 Brooke II



| Model No. | Item No. | Dimensions | Retail  |                               |                                    |       |
|-----------|----------|------------|---------|-------------------------------|------------------------------------|-------|
|           |          |            | B       | C                             | D                                  | E     |
|           |          |            | Orvieto | EuroSoft/<br>Marmo/<br>Spesso | King/ Mastrotto/<br>Ricco/ Vintage | Marco |

**AC74**

**1D**

**Chair**

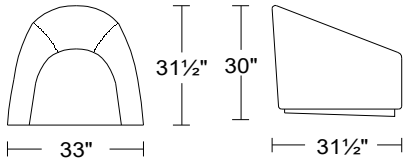

Width: 33"  
Height: 30"  
Depth: 31 1/2"

**AC74**

**1DV**

**Swivel Chair**

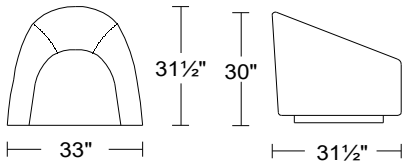

Width: 33"  
Height: 30"  
Depth: 31 1/2"

**AC74**

**ST**

**Ottoman**

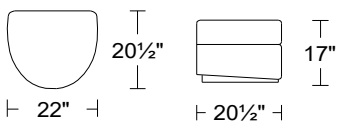

Width: 22"  
Height: 17"  
Depth: 20 1/2"

**AC74**

**STV**

**Swivel Ottoman**

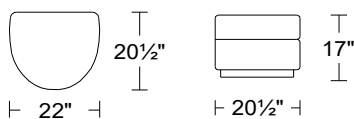

Width: 22"  
Height: 17"  
Depth: 20 1/2"

# PLANUM LEATHER

## Model AC75 Jade



| Model No. | Item No. | Dimensions   | Retail  |                               |                                    |       |
|-----------|----------|--------------|---------|-------------------------------|------------------------------------|-------|
|           |          |              | B       | C                             | D                                  | E     |
|           |          |              | Orvieto | EuroSoft/<br>Marmo/<br>Spesso | King/ Mastrotto/<br>Ricco/ Vintage | Marco |
| AC75      | 1DV      | Swivel Chair |         |                               |                                    |       |

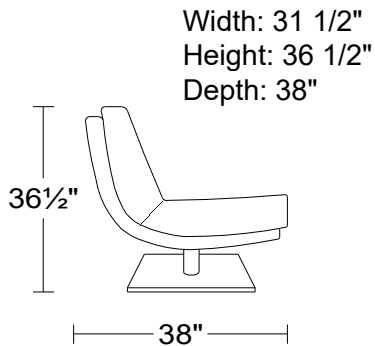
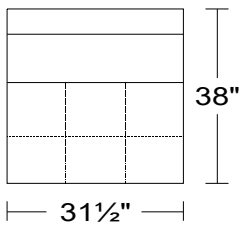

# PLANUM LEATHER

## Model AC84 Megan

Metal Arm/Legs are available in Antique Brass, Dark Nickel & Polished Stainless Steel



| Model No. | Item No. | Dimensions | Retail  |                               |                                    |       |
|-----------|----------|------------|---------|-------------------------------|------------------------------------|-------|
|           |          |            | B       | C                             | D                                  | E     |
|           |          |            | Orvieto | EuroSoft/<br>Marmo/<br>Spesso | King/ Mastrotto/<br>Ricco/ Vintage | Marco |

AC84

1D

Chair

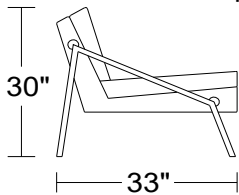
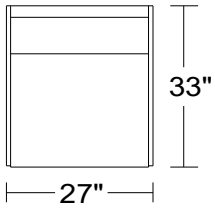

Width: 27"  
Height: 30"  
Depth: 33"

# PLANUM LEATHER

## Model AC85 Sammy



| Model No. | Item No. | Dimensions | Retail  |                               |                                    |       |
|-----------|----------|------------|---------|-------------------------------|------------------------------------|-------|
|           |          |            | B       | C                             | D                                  | E     |
|           |          |            | Orvieto | EuroSoft/<br>Marmo/<br>Spesso | King/ Mastrotto/<br>Ricco/ Vintage | Marco |

AC85

1DV

Swivel Chair

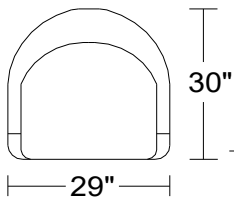

Width: 29"  
Height: 30"  
Depth: 30"

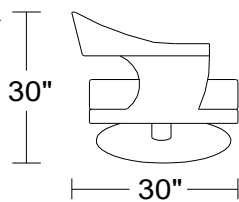

# PLANUM LEATHER

## Model AC86 Lulu



| Model No. | Item No. | Dimensions | Retail  |                               |                                    |       |
|-----------|----------|------------|---------|-------------------------------|------------------------------------|-------|
|           |          |            | B       | C                             | D                                  | E     |
|           |          |            | Orvieto | EuroSoft/<br>Marmo/<br>Spesso | King/ Mastrotto/<br>Ricco/ Vintage | Marco |

**AC86 1D Chair**

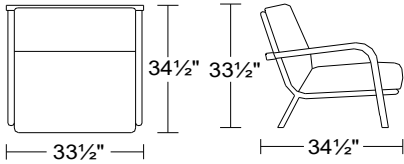

Width: 33 1/2"  
Height: 33 1/2"  
Depth: 34 1/2"

**AC86 1DAC Small Chair**

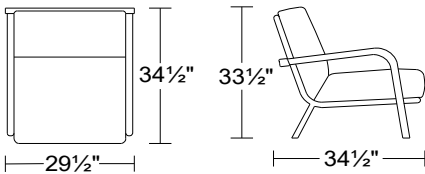

Width: 29 1/2"  
Height: 33 1/2"  
Depth: 34 1/2"

**AC86 ST Ottoman**

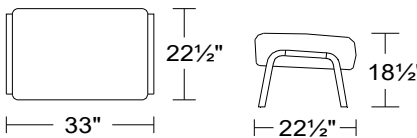

Width: 33"  
Height: 18 1/2"  
Depth: 22 1/2"

**AC86 STS Ottoman**

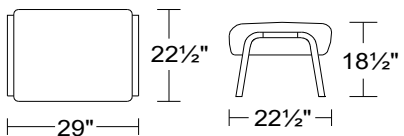

Width: 29"  
Height: 18 1/2"  
Depth: 22 1/2"



# PLANUM LEATHER

## Model AC89 Beau



| Model No. | Item No. | Dimensions | Retail  |                               |                                    |       |
|-----------|----------|------------|---------|-------------------------------|------------------------------------|-------|
|           |          |            | B       | C                             | D                                  | E     |
|           |          |            | Orvieto | EuroSoft/<br>Marmo/<br>Spesso | King/ Mastrotto/<br>Ricco/ Vintage | Marco |

AC89

1D

Chair

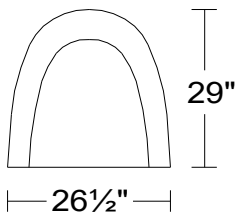

Width: 26 1/2"  
Height: 30 1/2"  
Depth: 29"

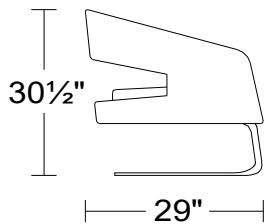

# PLANUM LEATHER

## Model AC92 Cast



| Model No. | Item No. | Dimensions | Retail  |                               |                                    |       |
|-----------|----------|------------|---------|-------------------------------|------------------------------------|-------|
|           |          |            | B       | C                             | D                                  | E     |
|           |          |            | Orvieto | EuroSoft/<br>Marmo/<br>Spesso | King/ Mastrotto/<br>Ricco/ Vintage | Marco |

AC92

1D

Chair

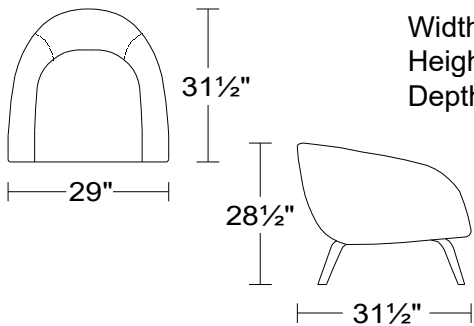

# PLANUM LEATHER

## Model AC93 Nico



| Model No. | Item No. | Dimensions | Retail  |                               |                                    |       |
|-----------|----------|------------|---------|-------------------------------|------------------------------------|-------|
|           |          |            | B       | C                             | D                                  | E     |
|           |          |            | Orvieto | EuroSoft/<br>Marmo/<br>Spesso | King/ Mastrotto/<br>Ricco/ Vintage | Marco |

AC93

1D

Chair

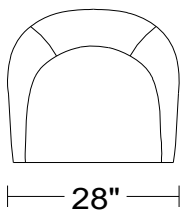

28 1/2"

Width: 28"  
Height: 30"  
Depth: 28 1/2"

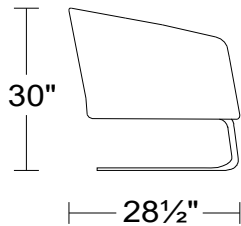

# PLANUM LEATHER

## Model AC95A Triangolo I



| Model No. | Item No. | Dimensions | Retail  |                               |                                    |       |
|-----------|----------|------------|---------|-------------------------------|------------------------------------|-------|
|           |          |            | B       | C                             | D                                  | E     |
|           |          |            | Orvieto | EuroSoft/<br>Marmo/<br>Spesso | King/ Mastrotto/<br>Ricco/ Vintage | Marco |

AC95A

1DV

Swivel Chair

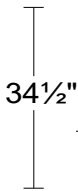
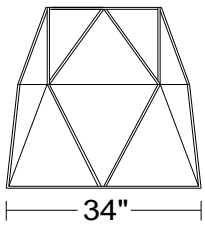

Width: 34"  
Height: 32"  
Depth: 34 1/2"

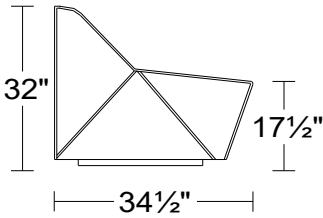

# PLANUM LEATHER

## Model AC95B Triangolo II Contrast Stripes in Metallic Leather (Prezioso)



| Model No. | Item No. | Dimensions | Retail  |                               |                                    |       |
|-----------|----------|------------|---------|-------------------------------|------------------------------------|-------|
|           |          |            | B       | C                             | D                                  | E     |
|           |          |            | Orvieto | EuroSoft/<br>Marmo/<br>Spesso | King/ Mastrotto/<br>Ricco/ Vintage | Marco |

AC95B

1DV

Swivel Chair

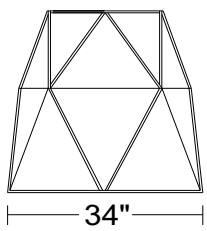

34 1/2"

Width: 34"  
Height: 32"  
Depth: 34 1/2"

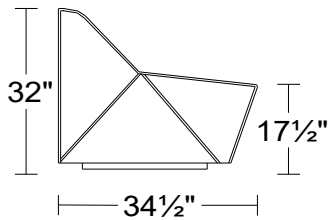

# PLANUM LEATHER

Model AC95C Triangolo III  
Multiple Leather Colors



| Model No. | Item No. | Dimensions | Retail  |                               |                                    |       |
|-----------|----------|------------|---------|-------------------------------|------------------------------------|-------|
|           |          |            | B       | C                             | D                                  | E     |
|           |          |            | Orvieto | EuroSoft/<br>Marmo/<br>Spesso | King/ Mastrotto/<br>Ricco/ Vintage | Marco |

AC95C

1DV

Swivel Chair

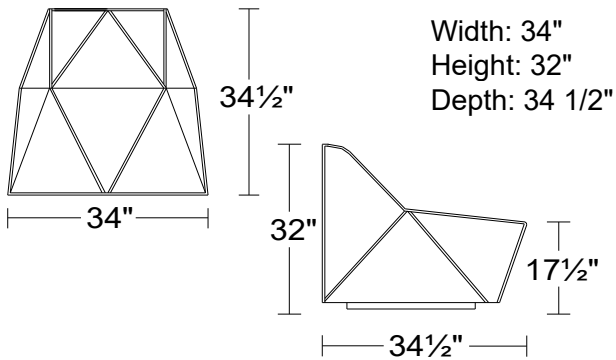

# PLANUM LEATHER

## Model AC96 Nicole

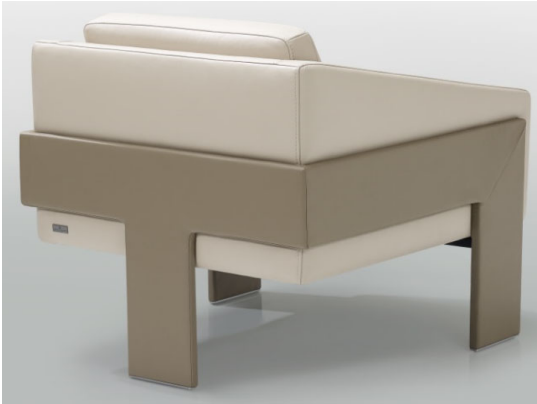

| Model No. | Item No. | Dimensions | Retail  |                               |                                    |       |
|-----------|----------|------------|---------|-------------------------------|------------------------------------|-------|
|           |          |            | B       | C                             | D                                  | E     |
|           |          |            | Orvieto | EuroSoft/<br>Marmo/<br>Spesso | King/ Mastrotto/<br>Ricco/ Vintage | Marco |
| AC96      | 1D       | Chair      |         |                               |                                    |       |

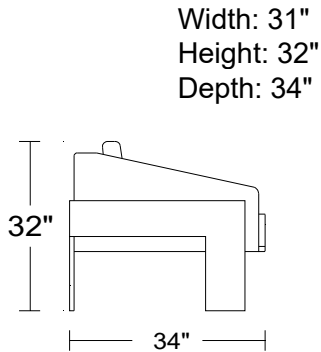
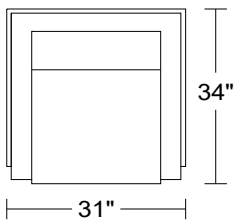

Width: 31"  
Height: 32"  
Depth: 34"

# PLANUM LEATHER

Model C007A/BM1 Lucy



| Model No. | Item No. | Dimensions | Retail  |                               |                                    |       |
|-----------|----------|------------|---------|-------------------------------|------------------------------------|-------|
|           |          |            | B       | C                             | D                                  | E     |
|           |          |            | Orvieto | EuroSoft/<br>Marmo/<br>Spesso | King/ Mastrotto/<br>Ricco/ Vintage | Marco |

C007A/BM1

1D

Chair

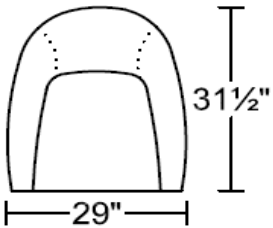

Width: 29"  
Height: 28 1/2"  
Depth: 31 1/2"

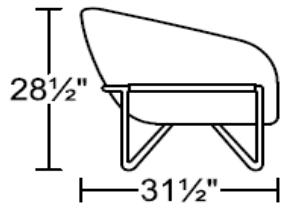



# PLANUM LEATHER

## Model C008A/BM1 Butaca II



| Model No. | Item No. | Dimensions | Retail  |                               |                                    |       |
|-----------|----------|------------|---------|-------------------------------|------------------------------------|-------|
|           |          |            | B       | C                             | D                                  | E     |
|           |          |            | Orvieto | EuroSoft/<br>Marmo/<br>Spesso | King/ Mastrotto/<br>Ricco/ Vintage | Marco |
| C008A/BM1 | 1D       | Chair      |         |                               |                                    |       |

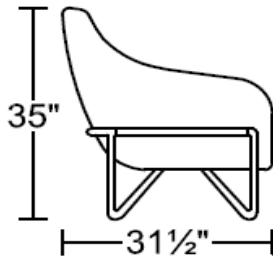
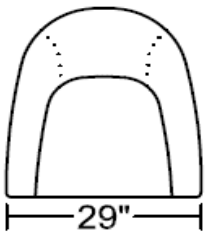

Width: 29"  
Height: 35"  
Depth: 31 1/2"

A= ALL LEATHER  
B= FABRIC/ LEATHER COMBINATION

# PLANUM LEATHER

## Model C009A/BM1 OLIMPIA I/II



| Model No. | Item No. | Dimensions | Retail  |                               |                                    |       |
|-----------|----------|------------|---------|-------------------------------|------------------------------------|-------|
|           |          |            | B       | C                             | D                                  | E     |
|           |          |            | Orvieto | EuroSoft/<br>Marmo/<br>Spesso | King/ Mastrotto/<br>Ricco/ Vintage | Marco |

C009A/BM1

1D

Chair

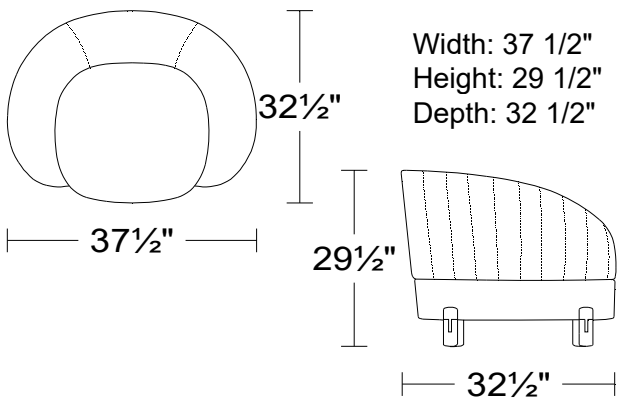

A= ALL LEATHER  
B= FABRIC/ LEATHER COMBINATION

# PLANUM LEATHER

Model C010A/BM1 NIX I/II



| Model No. | Item No. | Dimensions | Retail  |                               |                                    |       |
|-----------|----------|------------|---------|-------------------------------|------------------------------------|-------|
|           |          |            | B       | C                             | D                                  | E     |
|           |          |            | Orvieto | EuroSoft/<br>Marmo/<br>Spesso | King/ Mastrotto/<br>Ricco/ Vintage | Marco |

C010A/BM1

1D

Chair

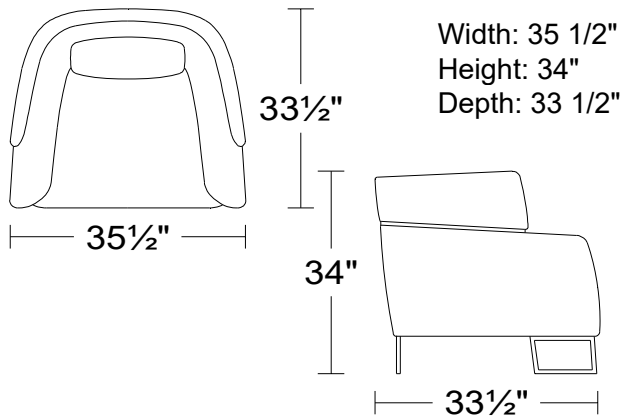

A= ALL LEATHER  
B= FABRIC/ LEATHER COMBINATION

# PLANUM LEATHER

Model C011A/BM1 Tita I/II



| Model No. | Item No. | Dimensions | Retail  |                               |                                    |       |
|-----------|----------|------------|---------|-------------------------------|------------------------------------|-------|
|           |          |            | B       | C                             | D                                  | E     |
|           |          |            | Orvieto | EuroSoft/<br>Marmo/<br>Spesso | King/ Mastrotto/<br>Ricco/ Vintage | Marco |

**C011A/BM1**

**1D**

**Chair**

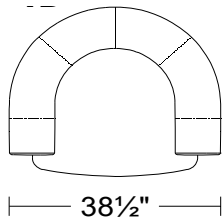

34 1/2"

38 1/2"

Width: 38 1/2"  
Height: 29"  
Depth: 34 1/2"

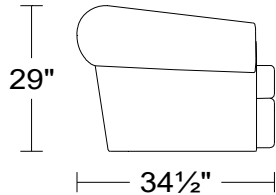

29"

34 1/2"

A= ALL LEATHER

B= FABRIC/ LEATHER COMBINATION

# PLANUM LEATHER

## Model C013DM1 Kalida V



| Model No. | Item No. | Dimensions | Retail  |                               |                                    |       |
|-----------|----------|------------|---------|-------------------------------|------------------------------------|-------|
|           |          |            | B       | C                             | D                                  | E     |
|           |          |            | Orvieto | EuroSoft/<br>Marmo/<br>Spesso | King/ Mastrotto/<br>Ricco/ Vintage | Marco |

C023DM1

1D

Chair

Width: 31"  
Height: 32"  
Depth: 31 1/2"

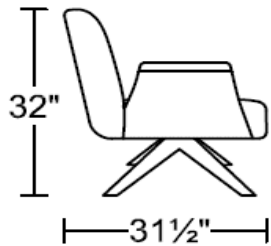
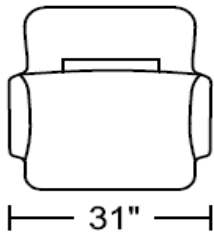

A= ALL LEATHER

B= FABRIC/ LEATHER COMBINATION

# PLANUM LEATHER

## Model C015A/BM1 Sulu I/II



| Model No. | Item No. | Dimensions | Retail  |                               |                                    |       |
|-----------|----------|------------|---------|-------------------------------|------------------------------------|-------|
|           |          |            | B       | C                             | D                                  | E     |
|           |          |            | Orvieto | EuroSoft/<br>Marmo/<br>Spesso | King/ Mastrotto/<br>Ricco/ Vintage | Marco |

C015A/BM1

1D

Chair

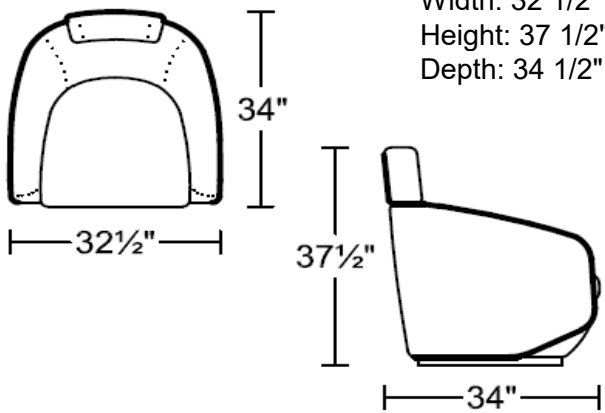

A= ALL LEATHER  
B= FABRIC/ LEATHER COMBINATION

# PLANUM LEATHER

Model C016A/BM1 Sulu III/IV



| Model No. | Item No. | Dimensions | Retail  |                               |                                    |       |
|-----------|----------|------------|---------|-------------------------------|------------------------------------|-------|
|           |          |            | B       | C                             | D                                  | E     |
|           |          |            | Orvieto | EuroSoft/<br>Marmo/<br>Spesso | King/ Mastrotto/<br>Ricco/ Vintage | Marco |

C016A/BM1

1D

Chair

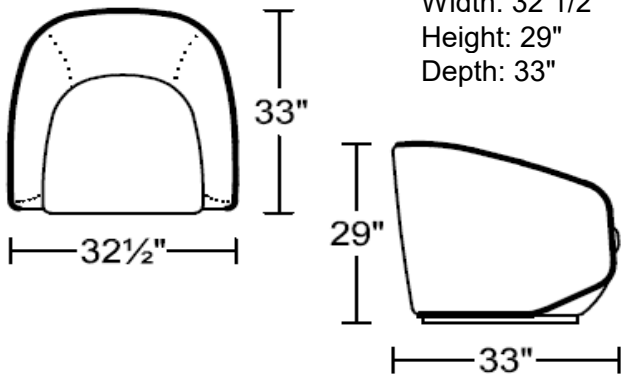

A= ALL LEATHER

B= FABRIC/ LEATHER COMBINATION

# PLANUM LEATHER

## Model C018C/DM1 Casia III/IV



| Model No. | Item No. | Dimensions | Retail  |                               |                                    |       |
|-----------|----------|------------|---------|-------------------------------|------------------------------------|-------|
|           |          |            | B       | C                             | D                                  | E     |
|           |          |            | Orvieto | EuroSoft/<br>Marmo/<br>Spesso | King/ Mastrotto/<br>Ricco/ Vintage | Marco |

**C018AC/DM1**

**1D**

**Chair**

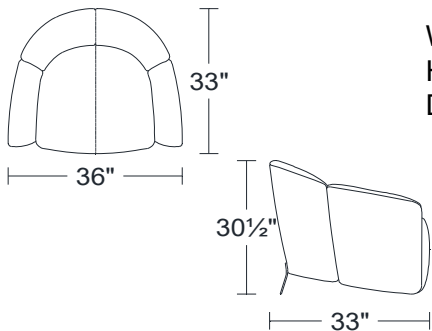

Width: 36"  
Height: 30 1/2"  
Depth: 33"

C= ALL LEATHER

D= FABRIC/ LEATHER COMBINATION



# PLANUM LEATHER

## Model C094A Pearl



| Model No. | Item No. | Dimensions | Retail  |                               |                                    |       |
|-----------|----------|------------|---------|-------------------------------|------------------------------------|-------|
|           |          |            | B       | C                             | D                                  | E     |
|           |          |            | Orvieto | EuroSoft/<br>Marmo/<br>Spesso | King/ Mastrotto/<br>Ricco/ Vintage | Marco |

**C094A**

**1D**

**Chair**

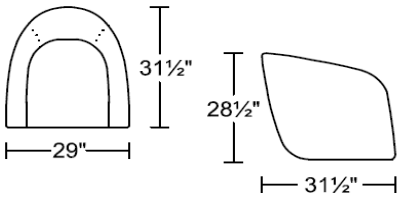

Width: 29"  
Height: 28 1/2"  
Depth: 31 1/2"

**C094A**

**1DV1**

**Swivel Chair  
w/ Pedestal**

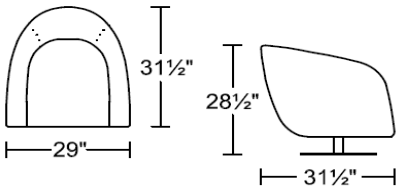

Width: 29"  
Height: 28 1/2"  
Depth: 31 1/2"

**C094A**

**1DV2**

**Swivel Chair**

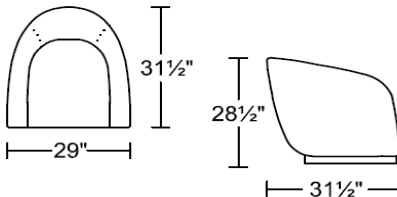

Width: 29"  
Height: 28 1/2"  
Depth: 31 1/2"

# PLANUM LEATHER

## Model AC97 Orchid



| Model No. | Item No. | Dimensions | Retail             |                   |         |                         |                                 |       |
|-----------|----------|------------|--------------------|-------------------|---------|-------------------------|---------------------------------|-------|
|           |          |            | FABRIC             |                   | LEATHER |                         |                                 |       |
|           |          |            | A1                 | B1                | B       | C                       | D                               | E     |
|           |          |            | Airborne / Karen 3 | Bembabis / Condor | Orvieto | EuroSoft/ Marmo/ Spesso | King/ Mastrotto/ Ricco/ Vintage | Marco |

AC97

1D

Chair

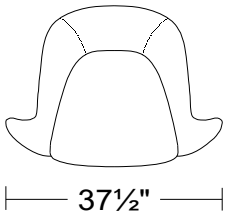

31"  
 Width: 37 1/2"  
 Height: 28 1/2"  
 Depth: 31"

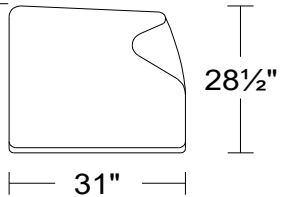

**Upcharge on Fabric for Fabric & Leather Mix:**

# PLANUM LEATHER

## Ottomans



| Model No. | Item No. | Dimensions | Retail  |                               |                                    |       |
|-----------|----------|------------|---------|-------------------------------|------------------------------------|-------|
|           |          |            | B       | C                             | D                                  | E     |
|           |          |            | Orvieto | EuroSoft/<br>Marmo/<br>Spesso | King/ Mastrotto/<br>Ricco/ Vintage | Marco |

**ST44**

**Square Ottoman**

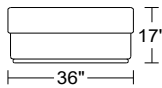
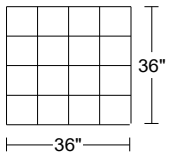

Width: 36"  
Height: 17"  
Depth: 36"

**ST45V**

**Round Ottoman**

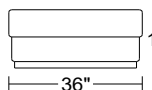
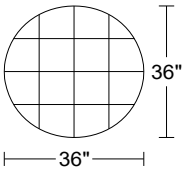

Width: 36"  
Height: 17"  
Depth: 36"

**ST57**

**Cubic Ottoman**

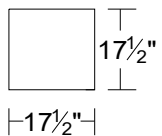
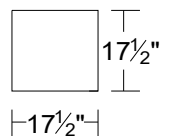

Width: 17 1/2"  
Height: 17 1/2"  
Depth: 17 1/2"

| Model No. | Dimensions | Retail  |                            |                                    |       |
|-----------|------------|---------|----------------------------|------------------------------------|-------|
|           |            | B       | C                          | D                                  | E     |
|           |            | Orvieto | EuroSoft/<br>Marmo/ Spesso | King/ Mastrotto/<br>Ricco/ Vintage | Marco |

## THROW PILLOWS

**A10**                      **Throw Pillow**

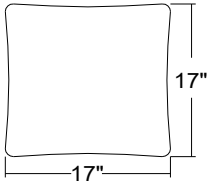

17" Square

**A53**                      **Bolster Pillow**

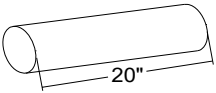

Length: 20"  
Diameter: 6"

**A55**                      **Throw Pillow**

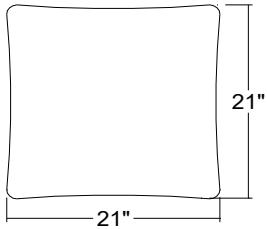

21" Square

**A68**                      **Throw Pillow w/  
KG Logo & Perforations**

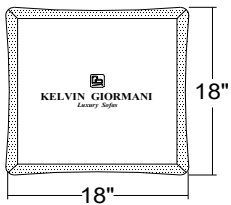

18" Square

**A78**                      **Lumbar Pillow**



Length: 32"  
Width: 10"

**A98**                      **Throw Pillow w/  
Perforations**

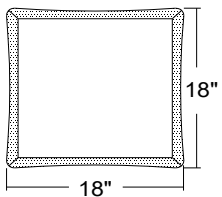

18" Square

# PLANUM FURNITURE LEATHER UPHOLSTERY LIMITED WARRANTY

PLANUM Furniture's handcrafted leather sofas and chairs are produced utilizing the finest available leathers and the best available hard woods, spring mechanisms and mechanical parts.

PLANUM warrants that all leather upholstery is produced with genuine leather.

While care is taken to provide consistency for each dye lot produced, the condition of the leather hide (i.e. the animal's skin) may result in small color and grain differences from samples supplied. This proves that the consumer is receiving genuine leather as the grain of no two hides is identical.

Planum warrants the leather against splitting and tearing under normal conditions of use.

Warranties are offered to the original purchaser only. All claims, when they arise, must be presented through the RETAILER from whom the product was originally purchased. Absent the ability to work through the original retailer, a consumer must be able to provide proof of original purchase which clearly states the name of the retailer, the date of purchase, and the product details. PLANUM Furniture will then offer direct assistance with any potential claim.

Service may be obtained under this warranty, when, under normal conditions of use, the purchased product has non-conformities that were not recognizable at the time of delivery and that are attributable to the manufacturer, after the product has been inspected, as required. The manufacturer offers no guarantees other than those stated here; your statutory rights under the relevant mandatory legal measures are not affected. The retailer and/or third parties may not alter the terms of this warranty, nor may they issue any other warranty statements in any form on the manufacturer's behalf. This warranty covers non-conformities in cushions, mattresses, reclining mechanisms, stitching, manual and/or, electronic mechanisms, suspension systems (webbing) and upholstery, that ARE NOT due to normal use.

PLANUM reserves the right to replace materials of similar quality standard if original material is no longer available.

PLANUM shall in no event be responsible for a direct, indirect, special, consequential or incidental damages such as (but not limited to) loss of use, sales or profit, loss of value which could have been created by the use of products. The responsibility of PLANUM should never exceed the repair or replacement cost of the products or part thereof which gives rise to claim.

INTERNAL FRAME (7 YEARS)  
SUSPENSION, MECHANISMS & BATTERIES (2 YEARS)  
CORE (3 YEARS)  
LEATHER COVERING (3 YEARS)

## This warranty does not cover:

- Non-conformities in products bought for nonresidential uses, i.e. environments other than the product's normal residential setting.
  - Faults or defects due to accidental damage, or improper installation.
  - Natural markings or creases caused by damage to the leather or by variations in the grain and color due to the leathers natural properties (characteristics that simply reflect the use of real leather).
  - Softening and flattening of cushions or pillows, which occurs naturally with normal use and aging of polyurethane foam, particularly during the first three months of use until the polyurethane foam stabilizes; relaxed cover tension resulting in some surface wrinkling should be expected as part of the stabilization process.
  - Cracking or peelings of the leather caused by animals, burns, cuts, or other forms of improper use.
  - Damaged caused by the user's negligence or by unsuitable cleaning or treatment of the upholstery.
  - Damage to the leather caused by the application of inappropriate chemicals, detergents, softeners or treatments not authorized by the manufacturer.
  - Damage caused by corrosive materials such as acid, solvents, dyes, inks, paints, or human or animal bodily fluids.
  - Damage from direct exposure to sunlight and/or heating source, and similar conditions, with resulting discoloration.
  - Product damage due to abuse, improper use, or force majeure.
  - Damage due to incorrect transport or handling of product.
  - Items sold as samples, as used goods, or "as is".
  - Damage due to repairs made by people not authorized by the manufacturer
- Matters interpreted as non-conformities because of incorrect information from, or negligence by, the retailer.
- Variations in tolerance – all products are handmade by skilled craftsmen using natural materials; each piece is unique, therefore exact tolerances cannot be achieved; deviations exist to a negligible extent within national and international standards for colors, measurements, and texture and do not represent material defect.
  - Difference in color between cover samples seen at time of purchase and cover received on final product.
  - Design, shape, and functional components may result in seating comfort variations within one upholstered unit (i.e. corner units and ratcheting or hinge internal components).
  - Any product sold by an unauthorized dealer.