

SLIDING COLLECTION

by ALEAL



PLANUM[®]
FURNITURE

Planum, Inc
Swedesford Corporate Center
619 B Swedesford Road
Frazer, PA 19355

Tel : 610/251-2120
Tel : 800/343-0042
Fax : 610/251-2290

email info@planumfurniture.com
visit us planumfurniture.com

ALEAL Finishes

LACQUER FINISHES



LC01 BLACK



LC02 WHITE



LC07 BRICK RED



LC11 TOMATO RED



LC12 SLATE GRAY



LC13 IVORY



LC14 METALLIC GRAY



LC15 GRAY BEIGE



LC16 FOG GRAY



LC18 METALLIC TAUPE



LC19 CAMOUFLAGE

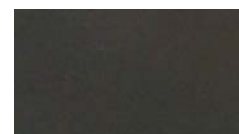

LC20 GUN METAL GRAY



LC21 MUSTARD YELLOW

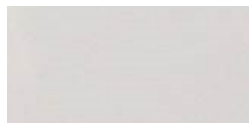

LC22 ASH GRAY



LC23 SILVER GRAY



LC26 BURGANDY



LC27 RUBY

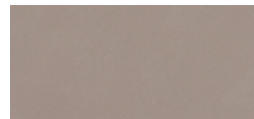

LC28 CAPPUCCINO



LC36 PEARL



LC37 PEWTER



LC38 PALOMINO



CHAMPAGNE



BRONZE



SILVER

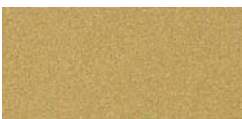

GOLD

Please Note:

- 1.) Custom RAL colors are acceptable, please add 10% upcharge (or minimum charge of \$260)
- 2.) Custom RAL colors need 60-120 day order delay.
- 3.) Is it the customers responsibility to send the sample of the desired color to Planum.
- 4.) Lastly all orders with custom colors will not be accepted as a return.

ALEAL Finishes

OAK & WALNUT FINISHES (ALWAYS 5% SHEEN)



CV01 Black Oak



CV09 Gray Beige Oak



CV02 Chocolate Oak



CV12 Ivory Oak



CV03 Slate Gray Oak



CV04 White Oak



CV11 Metallic Taupe Oak



CV05 Cherry Oak



CV10 Metallic Gray Oak



CV06 Natural Oak



CVL15 Opal Gray Oak



CVL14 Steel Gray Oak



CVL16 Smooth Chocolate Oak



Wild Oak



CVL17 Rustic Oak



NG01 Walnut

Please Note: Any OAK finish can be replaced with WALNUT with a 10% upcharge

ALEAL Finishes

CERAMIC FINISHES



ARENA



ARTIC WHITE



AVORIO



BARRO



BASALT BEIGE



BASALT BLACK



BELGIAN BLUE



BASALT GREY



CEMENT



IRON COPPER



IRON CORTEN



IRON GREY



IRON MOSS



LAVA



PERLA

Please Note: The above finishes can only be applied to certain pieces -- check price list

TABLE OF CONTENTS

	<u>PAGE #</u>
DINING ROOM	6
VITRINES	6 - 7
BAR UNIT	7
MEDIA CABINETS	8-9
PRE-DESIGNED CONFIGURATION	9-11
WALL MOUNTED UNITS	11-12
OCCASIONAL	12

Dining

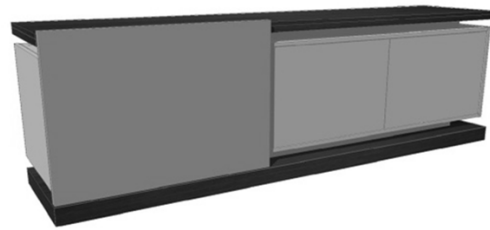

2 vol. / 1,229 m3 / 162 Kg



2 vol. / 1,033 m3 / 136 Kg



2 vol. / 0,338 m3 / 85 Kg



2 vol. / 0,350 m3 / 85 Kg

Description

Dimensions in Inches

Item No.	Finish	W	H	D
SLIDING Sideboard (Big Version)				
2x Doors 2x Lacquer Shelves 1x Tempered Glass Shelf				
		94 1/2"	31"	21 5/8"
SLIDIN-800	Oak Top & Plinth w/ Matte Lacquer Body and HG Lacquer Fronts			
UPCHARGE	Cutlery Insert			
UPCHARGE	LED Lights			
SLIDING Sideboard (Small Version)				
2x Doors 2x Lacquer Shelves 1x Tempered Glass Shelf				
		78 3/4"	31"	21 5/8"
SLIDIN-815	Oak Top & Plinth w/ Matte Lacquer Body and HG Lacquer Fronts			
UPCHARGE	Cutlery Insert			
UPCHARGE	LED Lights			
SLIDING Rectangular Extension Dining Table				
w/ 2x 21 5/8" Extension Leaves				
		74 7/8"	30 3/4"	39 3/8"
SLIDIN-802/1	All Oak			
SLIDIN-802/2	HG Lacquer Top w/ Oak Extensions & Feet			
SLIDIN-802/3	Glass Top w/ Oak Extensions & Feet			
SLIDIN-802/4	Ceramic Top w/ Oak Extensions & Feet			
Available at 63" wide w/ 2x 15 3/4" Extensions-- Same price as above				
SLIDING Square Extension Dining Table				
w/ 1x 25 5/8" Extension Leafs				
		55 1/8"	30 3/4"	55 1/8"
SLIDIN-804/1	All Oak			
SLIDIN-804/2	HG Lacquer Top w/ Oak Extensions & Feet			
SLIDIN-804/3	Glass Top w/ Oak Extensions & Feet			
SLIDIN-804/4	Ceramic Top w/ Oak Extensions & Feet			

Vitrine

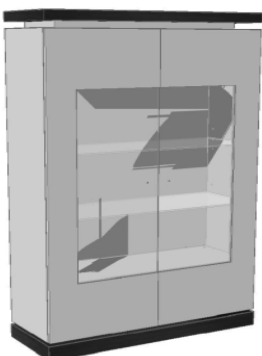

2 vol. / 1.094 m3 / 139 kg

SLIDING Vitrine

2x LED Projectors w/ Mirrored Back w/ Tempered Glass Shelf				
		47 1/4"	74 7/8"	17 3/8"
SLIDIN-816	Oak Top & Plinth w/ Matte Lacquer Body and HG Lacquer Fronts			
UPCHARGE	LED Lights (for the Top)			

Vitrine

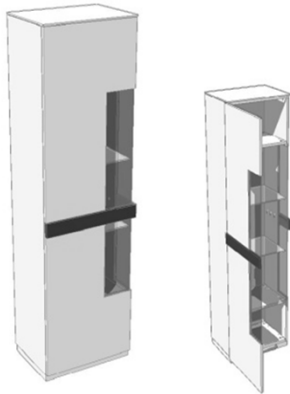
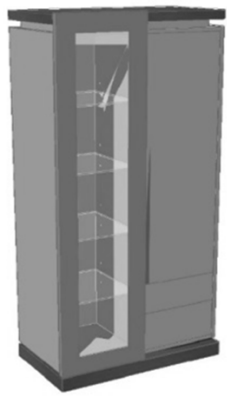

2 vol. / 0,637 m3 / 75 Kg

Description		Dimensions in Inches		
Item No.	Finish	W	H	D
SLIDING B Vitrine 1x Sliding Glass Door 2x Drawers 4x Glass Shelves w/ Interior Light		39 3/8"	82 5/8"	21 5/8"
SLIDIN-820	Oak Top & Plinth w/ Matte Lacquer Body and HG Lacquer Fronts			
UPCHARGE	LED Lights (for the Top)			
STRIPES 1 Door Vitrine w/out Stripes w/ Interior Light w/ Tempered Glass Shelf		23 5/8"	80 3/8"	17 3/4"
STRIPE-728	Matte Lacquer Body w/ HG Lacquer Fronts			

Mirror image available upon request

Bar Unit



2 vol. / 0,957 m3 / 140 Kg



SLIDING Bar Unit w/ Mirrored Back w/ Interior Light w/ Glass Shelf		47 1/4"	57"	21 5/8"
SLIDIN-801	Oak Top & Plinth w/ Matte Lacquer Body and HG Lacquer Fronts			
UPCHARGE	LED Lights (for the Top)			
SLIDING Bar Unit w/ Glass Door w/ Mirrored Back w/ Interior Light w/ Glass Shelf w/ 1x Drawer w/ Sliding Glass Door		47 1/4"	57"	21 5/8"
SLIDIN-819	Oak Top & Plinth w/ Matte Lacquer Body and HG Lacquer Fronts			
UPCHARGE	LED Lights (for the Top)			

Media Cabinets

Description	Dimensions in Inches				
	Item No.	Finish	W	H	D
SLIDING Media Cabinet (Big Version) 2x Doors 2x Lacquer Shelves 1x Drawer			94 1/2"	22 7/8"	21 5/8"
SLIDIN-817	Oak Top & Plinth w/ Matte Lacquer Body and HG Lacquer Fronts				
UPCHARGE	LED Lights				
SLIDING Media Cabinet (Small Version) 2x Doors 2x Lacquer Shelves 1x Drawer			78 3/4"	22 7/8"	21 5/8"
SLIDIN-818	Oak Top & Plinth w/ Matte Lacquer Body and HG Lacquer Fronts				
UPCHARGE	LED Lights				
SLIDING TV Unit 2x Drawers 1x Tempered Glass Shelf			114 1/4"	25 3/4"	21 5/8"
SLIDIN-827	Oak Top & Plinth w/ Matte Lacquer Body and HG Lacquer Fronts				
UPCHARGE	LED Lights				
SLIDING TV Unit 2x Drawers 1x Tempered Glass Shelf			94 1/2"	25 3/4"	21 5/8"
SLIDIN-826	Oak Top & Plinth w/ Matte Lacquer Body and HG Lacquer Fronts				
UPCHARGE	LED Lights				
			78 3/4"	25 3/4"	21 5/8"
SLIDIN-828	Oak Top & Plinth w/ Matte Lacquer Body and HG Lacquer Fronts				
UPCHARGE	LED Lights				
			63"	25 3/4"	21 5/8"
SLIDIN-829	Oak Top & Plinth w/ Matte Lacquer Body and HG Lacquer Fronts				
UPCHARGE	LED Lights				
SLIDING TV Unit (Big Version) 2x Drawers 1x Tempered Glass Shelf			94 1/2"	18 7/8"	21 5/8"
SLIDIN-807	Oak Top & Plinth w/ Matte Lacquer Body and HG Lacquer Fronts				
UPCHARGE	LED Lights				
SLIDING TV Unit (Small Version) 1x Drawer 1x Tempered Glass Shelf			63"	18 7/8"	21 5/8"
SLIDIN-806	Oak Top & Plinth w/ Matte Lacquer Body and HG Lacquer Fronts				
UPCHARGE	LED Lights				

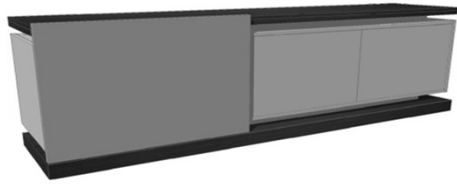

2 vol. / 1,229 m3 / 162 Kg
 2 vol. / 1,033 m3 / 136 Kg

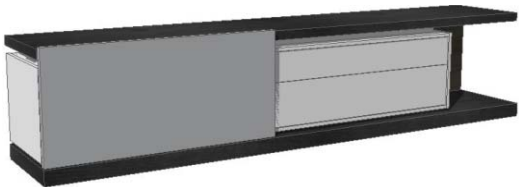

3 vol. / 1.211 m3 / 164 kg

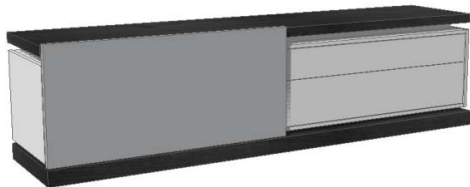

3 vol. / 1.200 m3 / 158 kg



1 vol. / 0,730 m3 / 85 Kg

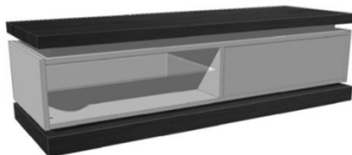

1 vol. / 0,533m3 / 93 Kg

Media Cabinets

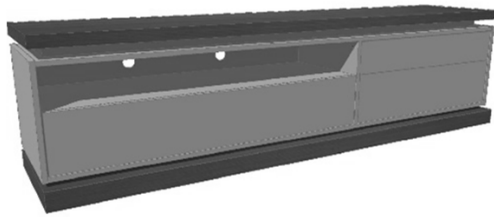

Description		Dimensions in Inches		
Item No.	Finish	W	H	D
SLIDING G TV Unit 3x Drawers		94 1/2"	25 3/8"	21 5/8"
SLIDIN-821	Oak Top & Plinth w/ Matte Lacquer Body and HG Lacquer Fronts			
UPCHARGE	LED Lights			

Pre-Designed Compositions

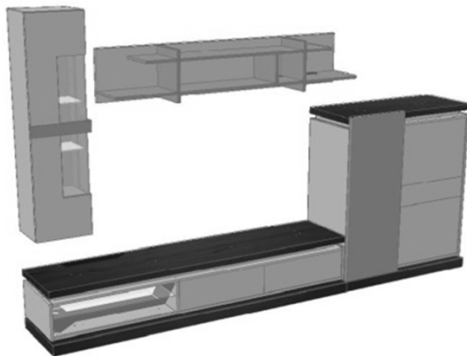

SLIDING A Composition Includes: SLIDING TV Unit 94 1/2" W (SLIDIN-807) SLIDING Bar Unit 57" H (SLIDIN-801) STRIPE Wall Vitrine Module 63" H (STRIPE-721) STRIPE Shelves Module 78 3/4" W (STRIPE-720)		141 3/4"	93 3/8"	21 5/8"
SLIDIN-808	Combination of Lacquer & Oak			
UPCHARGE	LED Lights			

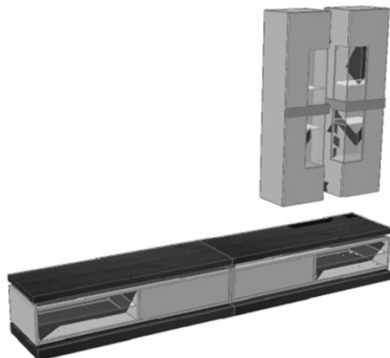

SLIDING B Composition Includes: SLIDING TV Unit 63" W (SLIDIN-806) SLIDING TV Unit 63" W (SLIDIN-806) STRIPE Wall Vitrine Module 63" H (STRIPE-721) STRIPE Wall Vitrine Module 63" H (STRIPE-721)		126"	93 3/8"	21 5/8"
SLIDIN-809	Combination of Lacquer & Oak			
UPCHARGE	LED Lights			

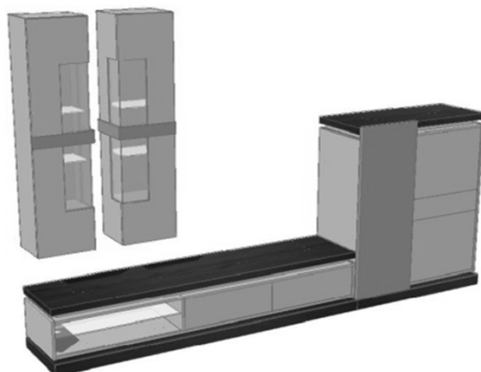

SLIDING C Composition Includes: STRIPE Wall Vitrine Module 63" H (STRIPE-721) STRIPE Wall Vitrine Module 63" H (STRIPE-721) SLIDING TV Unit 94 1/2" W (SLIDIN-807) SLIDING Bar Unit 57" H (SLIDIN-801)		141 3/4"	93 3/8"	21 5/8"
SLIDIN-810	Combination of Lacquer & Oak			
UPCHARGE	LED Lights			

Pre-Designed Compositions

Description

Dimensions in Inches

Item No.	Finish	W	H	D
SLIDING D Composition Includes: STRIPES Shelves Module 55 1/8" W (STRIPE-719) STRIPES Shelves Module 55 1/8" W (STRIPE-719) SLIDING TV Unit 94 1/2" W (SLIDIN-807)				
		94 1/2"	85 1/2"	21 5/8"
SLIDIN-811	Combination of Lacquer & Oak			
UPCHARGE	LED Lights			
SLIDING E Composition Includes: SLIDING TV Unit 63" W (SLIDIN-806) SLIDING Bar Unit 57" H (SLIDIN-801)				
		110 1/4"	57"	21 5/8"
SLIDIN-812	Combination of Lacquer & Oak			
UPCHARGE	LED Lights			
STRIPES E Composition Includes: 2x STRIPES 1 Door Vitrine (STRIPE-728)				
		59"	80 3/8"	17 3/4"
STRIPE-734	Combination of Lacquer & Oak			
SLIDING F Composition Includes: w/ Drop-Lid Wall Module TV Unit w/ Sliding Door & 2x Drawers 1x Tempered Glass Shelf				
		126"	70 7/8"	21 5/8"
SLIDIN-823	Complete Composition- Combination of Lacquer & Oak			
UPCHARGE	LED Lights			
		63"	45 1/2"	13"
SLIDIN-823/W	Wall Modules Only - Combination of Lacquer & Oak			
		114 1/4"	25 3/4"	21 5/8"
SLIDIN-823/MC	Media Cabinet Only - Combination of Lacquer & Oak			

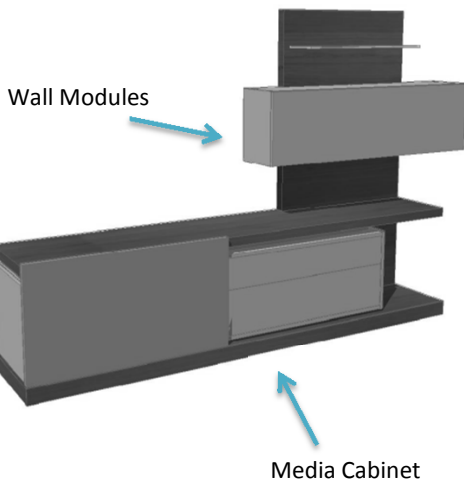
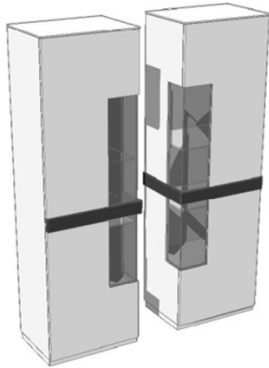
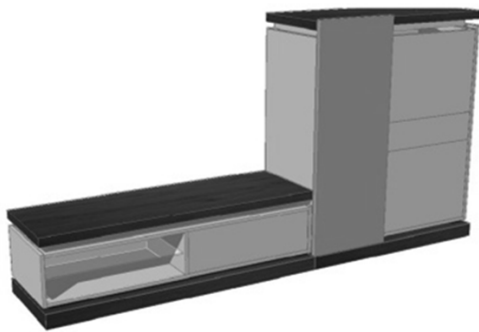
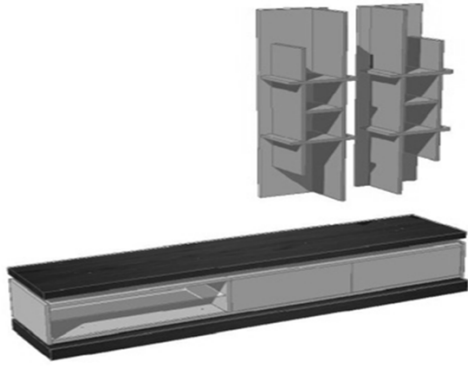

Pre-Designed Compositions

Description

Dimensions in Inches

Item No.	Finish	W	H	D
----------	--------	---	---	---

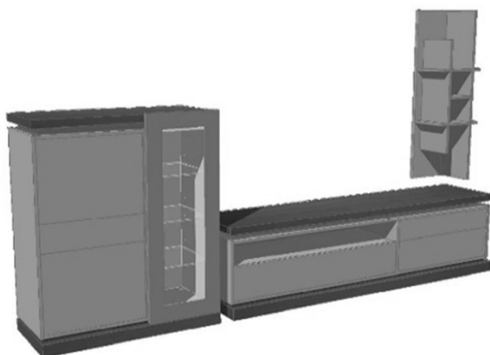

SLIDING G Composition Includes:
 SLIDING Bar Unit 63" H (SLIDIN-819)
 SLIDING G TV Unit 94 1/2" W (SLIDIN-821)
 STRIPES Shelves Module 55 1/8" W (STRIPE-719)
 145 5/8"

84 1/2"

21 5/8"

SLIDIN-824	Combination of Lacquer & Oak
-------------------	------------------------------

UPCHARGE	LED Lights
-----------------	------------

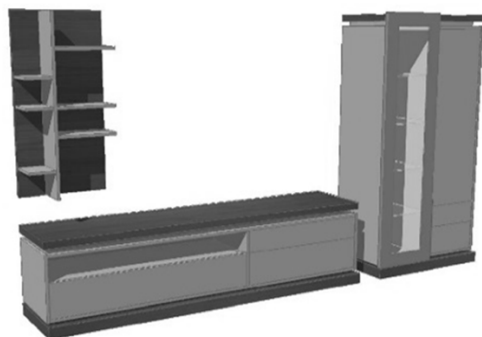

SLIDING H Composition Includes:
 SLIDING G TV Unit 94 1/2" W (SLIDIN-821)
 SLIDING B Vitrine 82 5/8" H (SLIDIN-820)
 SLIDING Shelf Module 23 5/8"W (SLIDING-822)
 141 3/4"

82 5/8"

21 5/8"

SLIDIN-825	Combination of Lacquer & Oak
-------------------	------------------------------

UPCHARGE	LED Lights
-----------------	------------

Wall Mounted Modules

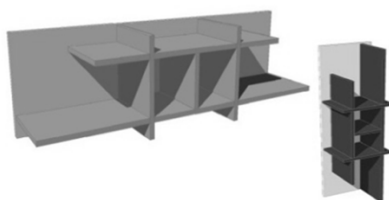

1 vol. / 0,220 m3 / 28 Kg

STRIPES Shelves Module

55 1/8"

15 3/4"

13"

STRIPE-719	HG Lacquer Shelves w/ Matte Lacquer Back
-------------------	--

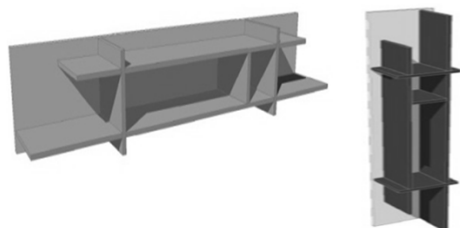

1 vol. / 0,319 m3 / 39 Kg

STRIPES Shelves Module

78 3/4"

15 3/4"

13"

STRIPE-720	HG Lacquer Shelves w/ Matte Lacquer Back
-------------------	--

PLEASE NOTE: It is the responsibility of the customer to ensure that the correct hardware is used when hanging the mirror/wall n manufacturer cannot supply hardware for every type of situation.

Wall Mounted Modules

Description

Dimensions in Inches

Item No.	Finish	W	H	D
----------	--------	---	---	---



SLIDING Shelf Module

23 5/8"

49 5/8"

10 3/8"

SLIDIN-822	HG Lacquer Shelves w/ Oak Back			
-------------------	--------------------------------	--	--	--

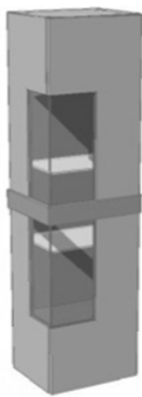

STRIPES Wall Vitrine

w/ Interior Light
w/ Tempered glass shelves

15 3/4"

63"

13"

STRIPE-721	Matte Laquer Body w/ HG Lacquer Door & Handle			
-------------------	---	--	--	--

Mirror image available upon request

2 vol. / 0,296 m3 / 44 Kg

Occasional

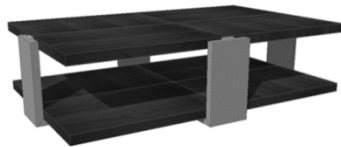

SLIDING Coffee Table

53 1/2"

14 1/2"

33 7/8"

SLIDIN-813	Oak Top & Base w/ HG Lacquer Legs			
-------------------	-----------------------------------	--	--	--

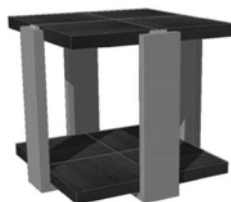

SLIDING End Table

23 5/8"

20 1/4"

23 5/8"

SLIDIN-814	Oak Top & Base w/ HG Lacquer Legs			
-------------------	-----------------------------------	--	--	--