

# STRIPES COLLECTION

by ALEAL



**PLANUM**<sup>®</sup>  
FURNITURE

Planum, Inc  
Swedesford Corporate Center  
619 B Swedesford Road  
Frazer, PA 19355

email [info@planumfurniture.com](mailto:info@planumfurniture.com)  
visit us [planumfurniture.com](http://planumfurniture.com)

Tel : 610/251-2120  
Tel : 800/343-0042  
Fax : 610/251-2290

# ALEAL Finishes

## LACQUER FINISHES



LC01 BLACK

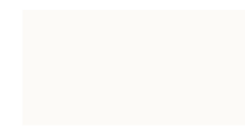

LC02 WHITE



LC07 BRICK RED



LC11 TOMATO RED



LC12 SLATE GRAY

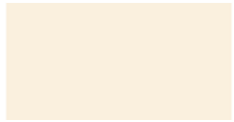

LC13 IVORY



LC14 METALLIC GRAY



LC15 GRAY BEIGE



LC16 FOG GRAY



LC18 METALLIC TAUPE



LC19 CAMOUFLAGE

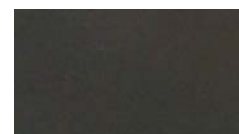

LC20 GUN METAL GRAY



LC21 MUSTARD YELLOW

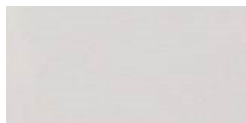

LC22 ASH GRAY



LC23 SILVER GRAY



LC26 BURGANDY



LC27 RUBY

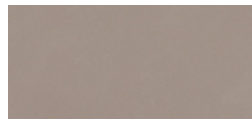

LC28 CAPPUCCINO



LC36 PEARL



LC37 PEWTER



LC38 PALOMINO



CHAMPAGNE



BRONZE



SILVER

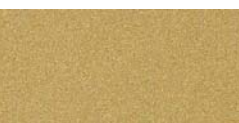

GOLD

### Please Note:

- 1.) Custom RAL colors are acceptable, please add 10% upcharge (or minimum charge of \$260)
- 2.) Custom RAL colors need 60-120 day order delay.
- 3.) Is it the customers responsibility to send the sample of the desired color to Planum.
- 4.) Lastly all orders with custom colors will not be accepted as a return.

# ALEAL Finishes

OAK & WALNUT FINISHES (Always 5% Sheen - Matte)



CV01 Black Oak



CV09 Gray Beige Oak



CV02 Chocolate Oak



CV12 Ivory Oak



CV03 Slate Gray Oak



CV04 White Oak



CV11 Metallic Taupe Oak



CV05 Cherry Oak



CV10 Metallic Gray Oak



CV06 Natural Oak



CVL15 Opal Gray Oak



CVL14 Steel Gray Oak

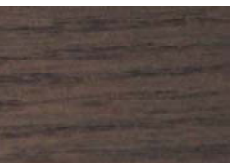

CVL16 Smooth Chocolate Oak



Wild Oak



CVL17 Rustic Oak



NG01 Walnut

\*\*\*Please Note: Any OAK finish can be replaced with WALNUT with a 10% upcharge\*\*\*

# ALEAL Finishes

## LEAF FINISHES



**FHCH Champagne Leaf**



**FHOR Gold Leaf**



**FHPR Silver Leaf**



**FHBZ Bronze Leaf**

# TABLE OF CONTENTS

	<u>PAGE #</u>
DINING ROOM	6
VITRINE	6
BAR UNITS	6-7
MEDIA CABINETS	7
PRE-DESIGNED CONFIGURATIONS	7-9
MODULAR UNITS	9-10
WALL MOUNTED UNITS	10-11

## Dining

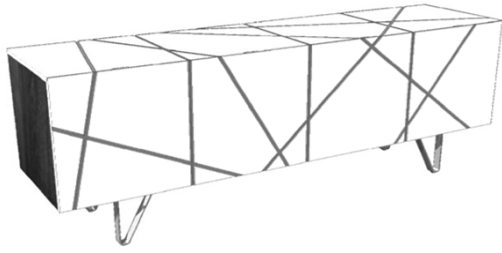

3 vol. / 0,876 m3 / 113 Kg

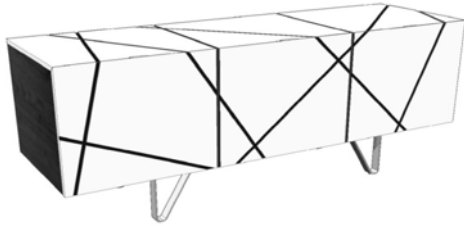

3 vol. / 0,760 m3 / 97 Kg

Description		Dimensions in Inches		
Item No.	Finish	W	H	D
<b>STRIPES Sideboard</b> 4x Doors 2x Glass Shelves & 1x Drawer w/ Stainless Steel Legs		86 5/8"	31 1/2"	21 5/8"
<b>STRIFE-700</b>	HG Lacquer Top & Doors w/ Oak Sides; Lacquer Stripes			
<b>UPCHARGE</b>	Cutlery Inserts			
<b>STRIPES Sideboard</b> 3x Doors 2x Glass Shelves & 1x Drawer w/ Stainless Steel Legs		70 7/8"	31 1/2"	21 5/8"
<b>STRIFE-701</b>	HG Lacquer Top & Doors w/ Oak Sides; Lacquer Stripes			
<b>UPCHARGE</b>	Cutlery Inserts			

## Vitrines

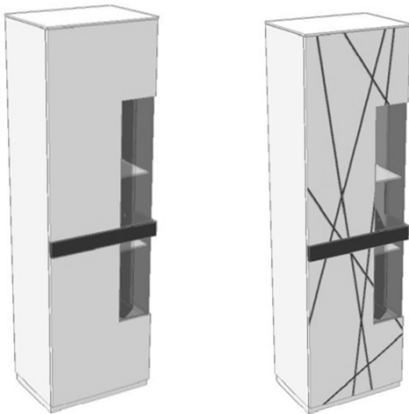

2 vol. / 0,637 m3 / 75 Kg

<b>STRIPES 1 Door Vitrine w/out Stripes</b> w/ Interior Light w/ Tempered Glass Shelves		23 5/8"	80 3/8"	17 3/4"
<b>STRIFE-728</b>	Matte Lacquer Structure w/ HG Lacquer Door & Handle			
**Mirror image available upon request**				
<b>STRIPES 1 Door Vitrine w/ Stripes</b> w/ Lacquer Stripes in Optional Color w/ Interior Light w/ Tempered Glass Shelves		23 5/8"	80 3/8"	17 3/4"
<b>STRIFE-729</b>	Matte Lacquer Structure w/ HG Lacquer Door & Handle			

\*\*Mirror image available upon request\*\*

## Bar Unit

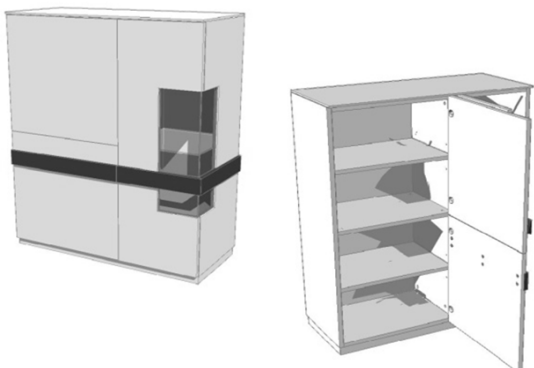

2 vol. / 0,722 m3 / 84 Kg

<b>STRIPES Vitrine Bar w/out Stripes</b> w/ Lacquer Shelves w/ LED Projector		39 3/8"	49 1/4"	17 3/4"
<b>STRIFE-726</b>	Matte Lacquer Structure w/ HG Lacquer Door & Handle			

\*\*Mirror image available upon request\*\*

## Bar Unit

### Description

### Dimensions in Inches

Item No.	Finish	W	H	D
----------	--------	---	---	---

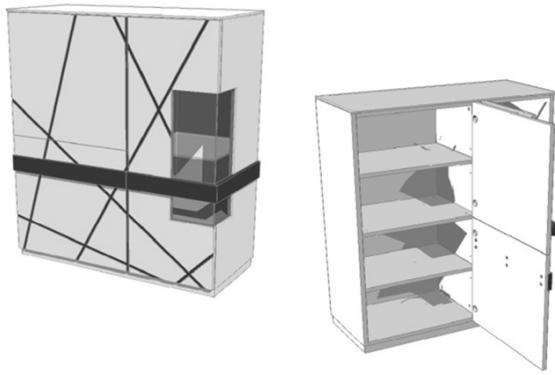

**STRIPES Vitrine Bar w/ Stripes**  
 w/ Lacquer Stripes in Optional Color  
 w/ Lacquer Shelves  
 w/ LED Projector

39 3/8"	49 1/4"	17 3/4"
---------	---------	---------

<b>STRIPE-727</b>	Matte Lacquer Structure w/ HG Lacquer Door & Handle
-------------------	---

\*\*Mirror image available upon request\*\*

2 vol. / 0,722 m3 / 84 Kg

## Media Cabinet

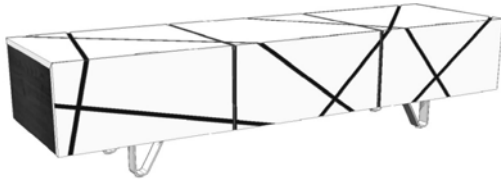

**STRIPES Media Cabinet**  
 w/ 2x Drawers & 1x Drop-lip  
 w/ Stainless Steel Legs

63"	16 1/2"	18 1/8"
-----	---------	---------

<b>STRIPE-703</b>	HG Lacquer Top & Doors w/ Oak Sides; Lacquer Stripes
-------------------	--

2 vol. / 0,360 m3 / 66 Kg

## Pre-Designed Configurations

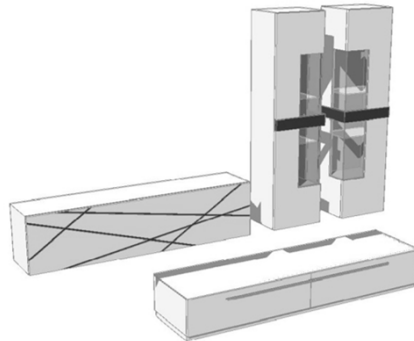

**STRIPES Composition A Includes:**  
 Drop Lid Door Module 63" W (STRIPES-718)  
 Wall Vitrine Module 63" H (STRIPE-721)  
 Wall Vitrine Module 63" H (STRIPE-721)  
 Low Base 78 3/4" W (STRIPE-708)

118 1/8"	87 7/8"	20 5/8"
----------	---------	---------

<b>STRIPE-730</b>	Combination of Matte & HG Lacquer
-------------------	-----------------------------------

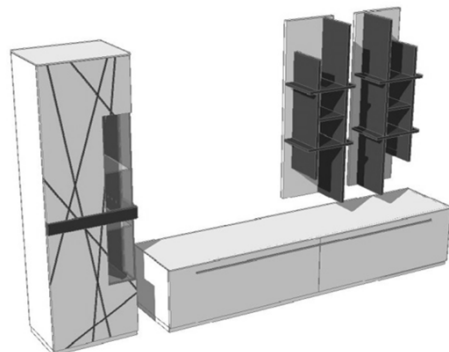

**STRIPES Composition B Includes:**  
 1 Door Vitrine 80 3/8" H (STRIPE-729)  
 High Base 94 1/2" W (STRIPE-712)  
 Shelf Module 55 1/8" W (STRIPE-719)  
 Shelf Module 55 1/8" W (STRIPE-719)

126"	80 3/8"	20 5/8"
------	---------	---------

<b>STRIPE-731</b>	Combination of Matte & HG Lacquer
-------------------	-----------------------------------

# Pre-Designed Configurations

## Description

## Dimensions in Inches

Item No.	Finish	W	H	D
<b>STRIPES Composition C Includes:</b> Wall Vitrine Module 63" H (STRIPE-722) Wall Vitrine Module 63" H (STRIPE-722) Plinth 47 1/4" W (STRIPE-713) High Base 94 1/2" W (STRIPE-712) Shelf Module 55 1/8" W (STRIPE-719) Shelf Module 55 1/8" W (STRIPE-719)				
		141 3/4"	82 3/4"	20 5/8"
<b>STRIFE-732</b>	Combination of Matte & HG Lacquer			
<b>STRIPES Composition D Includes:</b> Wall Vitrine Module 63" H (STRIPE-721) Shelf Module 78 3/4" W (STRIPE-720) Stacking Platform 78 3/4" W (STRIPE-724) Low Base 78 3/4" W (STRIPE-708) Vitrine Bar (STRIPE-727)				
		118 7/8"	96"	20 5/8"
<b>STRIFE-733</b>	Combination of Matte & HG Lacquer			
<b>STRIPES Composition E Includes:</b> 2x 1 Door Vitrine (STRIPE-728)				
		59"	80 3/8"	17 3/4"
<b>STRIFE-734</b>	Combination of Matte & HG Lacquer			
<b>STRIPES Composition F Includes:</b> 1 Door Vitrine (STRIPE-728) Shelf Module 78 3/4" W (STRIPE-720) Stacking Platform 63" W (STRIPE-723) Low Base 63" W (STRIPE-707) Vitrine Bar (STRIPE-727)				
		126"	80 3/8"	20 5/8"
<b>STRIFE-735</b>	Combination of Matte & HG Lacquer			
<b>STRIPES Composition G Includes:</b> Vitrine Bar (STRIPE-727) Shelf Module 78 3/4" W (STRIPE-720) Low Base 78 3/4" W (STRIPE-708) Wall Vitrine Module 63" H (STRIPE-721)				
		118 1/8"	87 7/8"	20 5/8"
<b>STRIFE-736</b>	Combination of Matte & HG Lacquer			

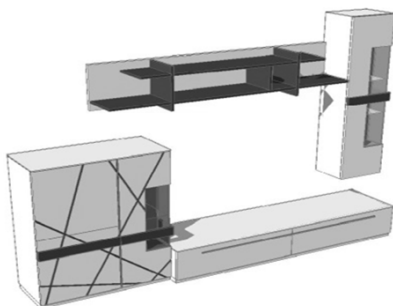
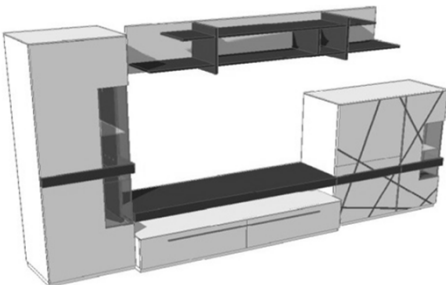
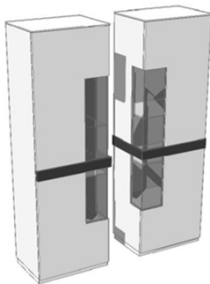
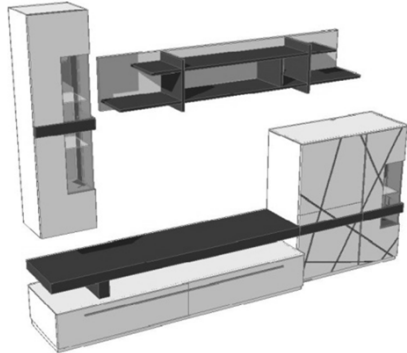
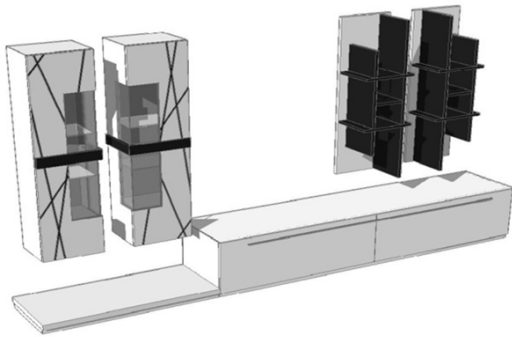



## Pre-Designed Configurations

### Description

### Dimensions in Inches

Item No.	Finish	W	H	D
<b>STRIPES Composition H Includes:</b> High Base 78 3/4" W (STRIPE-711) Plinth 47 1/4" W (STRIPE-713) Shelf Module 55 1/8" W (STRIPE-719) Wall Vitrine Module 63" H (STRIPE-722) Wall Vitrine Module 63" H (STRIPE-722)				
		126"	87 7/8"	20 5/8"
<b>STRIFE-737</b>	Combination of Matte & HG Lacquer			

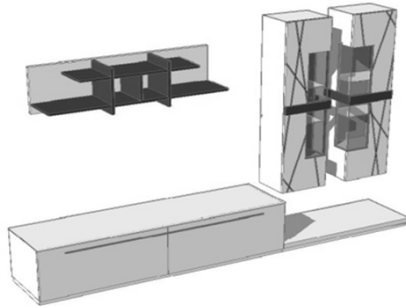

## Modular Units - Low Base

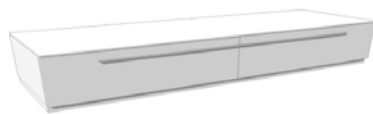

1 vol. / 0,277 m3 / 61 Kg

<b>STRIPES Low Base - 63"W</b> 2x Drawers				
		63"	13"	20 5/8"
<b>STRIFE-707</b>	Matte Lacquer Structure w/ HG Lacquer Fronts			



1 vol. / 0,448 m3 / 76 Kg

<b>STRIPES Low Base - 78 3/4"W</b> 2x Drawers				
		78 3/4"	13"	20 5/8"
<b>STRIFE-708</b>	Matte Lacquer Structure w/ HG Lacquer Fronts			

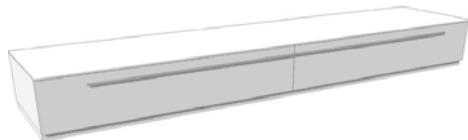

1 vol. / 0,416 m3 / 91 Kg

<b>STRIPES Low Base - 94 1/2"W</b> 2x Drawers				
		94 1/2"	13"	20 5/8"
<b>STRIFE-709</b>	Matte Lacquer Structure w/ HG Lacquer Fronts			

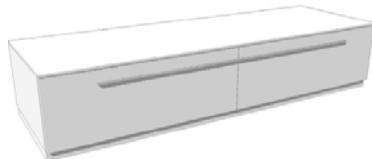

1 vol. / 0,420 m3 / 74 Kg

<b>STRIPES High Base - 63"W</b> 2x Drop-Lids & Interior Shelves 1x Pull-out shelf on right side				
		63"	19 3/4"	20 5/8"
<b>STRIFE-710</b>	Matte Lacquer Structure w/ HG Lacquer Fronts			

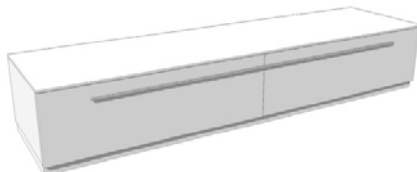

1 vol. / 0,716m3 / 92 Kg

<b>STRIPES High Base - 78 3/4"W</b> 2x Drop-Lids & Interior Shelves 1x Pull-out shelf on right side				
		78 3/4"	19 3/4"	20 5/8"
<b>STRIFE-711</b>	Matte Lacquer Structure w/ HG Lacquer Fronts			

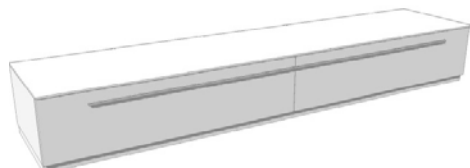

1 vol. / 0,630 m3 / 110 Kg

<b>STRIPES High Base - 94 1/2"W</b> 2x Drop-Lids & Interior Shelves 1x Pull-out shelf on right side				
		94 1/2"	19 3/4"	20 5/8"
<b>STRIFE-712</b>	Matte Lacquer Structure w/ HG Lacquer Fronts			

## Free Standing Plinths

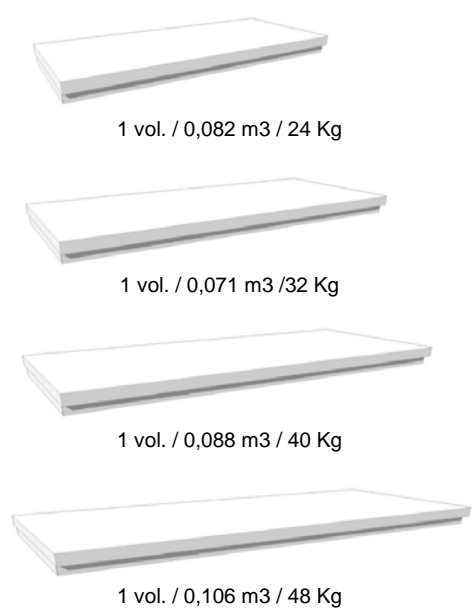

Description		Dimensions in Inches		
Item No.	Finish	W	H	D
<b>STRIPES Plinth - 47 1/4"W</b>		47 1/4"	3 3/8"	20 1/2"
<b>STRIPE-713</b>	Matte Lacquer			
<b>STRIPES Plinth - 63"W</b>		63"	3 3/8"	20 1/2"
<b>STRIPE-714</b>	Matte Lacquer			
<b>STRIPES Plinth - 78 3/4"W</b>		78 3/4"	3 3/8"	20 1/2"
<b>STRIPE-715</b>	Matte Lacquer			
<b>STRIPES Plinth - 94 1/2"W</b>		94 1/2"	3 3/8"	20 1/2"
<b>STRIPE-716</b>	Matte Lacquer			

## Stacking Platform w/ Spacer



<b>STRIPES Stacking Platform - 63"W</b>		63"	8 1/4"	18"
<b>STRIPE-723</b>	Matte or HG Lacquer			
1 vol. / 0,153 m3 / 24 Kg				
<b>STRIPES Stacking Platform - 78 3/4"W</b>		78 3/4"	8 1/4"	18"
<b>STRIPE-724</b>	Matte or HG Lacquer			
1 vol. / 0,148 m3 / 30 Kg				
<b>STRIPES Stacking Platform - 94 1/2"W</b>		94 1/2"	8 1/4"	18"
<b>STRIPE-725</b>	Matte or HG Lacquer			
1 vol. / 0,229 m3 / 36 Kg				

## Wall Mounted Modules

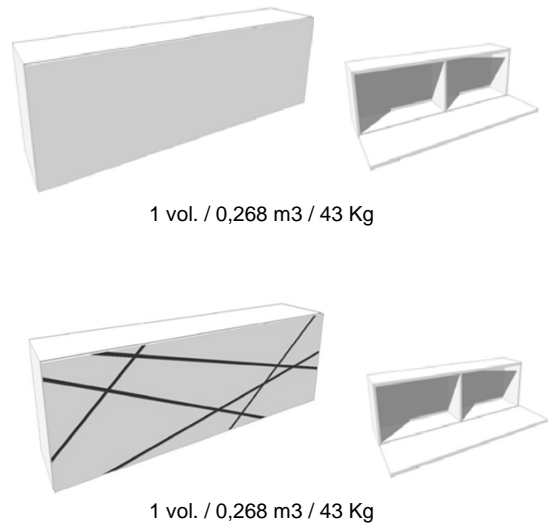

<b>STRIPES Drop-Lid Module w/out Stripes</b>		63"	15 3/4"	13"
<b>STRIPE-717</b>	Matte Lacquer Structure w/ HG Lacquer Fronts			
**Available w/ Pull-Up door upon request**				
<b>STRIPES Drop-Lid Module w/ Stripes</b> w/ Lacquer Stripes in Optional Color		63"	15 3/4"	13"
<b>STRIPE-718</b>	Matte Lacquer Structure w/ HG Lacquer Fronts			
**Available w/ Pull-Up door upon request**				

# Wall Mounted Modules

## Description

## Dimensions in Inches

Item No.      Finish      W      H      D

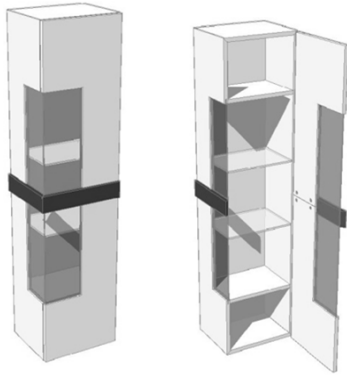

**STRIPES Wall Vitrine w/out Stripes**  
w/ Interior Light  
w/ Tempered glass shelves

15 3/4"

63"

13"

**STRIPE-721** Matte Lacquer Structure w/ HG Lacquer Door & Handle

\*\*Mirror image available upon request\*\*

2 vol. / 0,296 m3 / 44 Kg

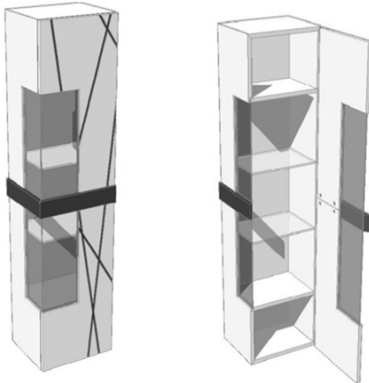

**STRIPES Wall Vitrine w/ Stripes**  
w/ Lacquer Stripes in Optional Color  
w/ Interior Light  
w/ Tempered Glass Shelves

15 3/4"

63"

13"

**STRIPE-722** Matte Lacquer Structure w/ HG Lacquer Door & Handle

\*\*Mirror image available upon request\*\*

2 vol. / 0,296 m3 / 44 Kg

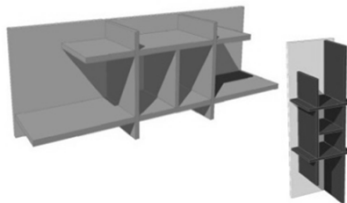

**STRIPES Shelf Module**

55 1/8"

15 3/4"

13"

**STRIPE-719** HG Lacquer Shelves w/ Matte Lacquer Back

1 vol. / 0,220 m3 / 28 Kg

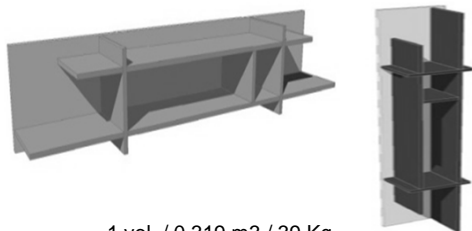

**STRIPES Shelf Module**

78 3/4"

15 3/4"

13"

**STRIPE-720** HG Lacquer Shelves w/ Matte Lacquer Back

1 vol. / 0,319 m3 / 39 Kg

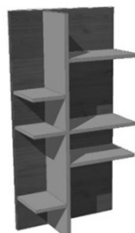

**SLIDING Shelf Module**

23 5/8"

49 5/8"

10 3/8"

**SLIDIN-822** HG Lacquer Shelves w/ Oak Back

**PLEASE NOTE:** It is the responsibility of the customer to ensure that the correct hardware is used when hanging the mirror/wall modules; manu cannot supply hardware for every type of situation.