

# LUV

## INDERA COLLECTION

### Retail Price List



PRICING EFFECTIVE 10.01.2023

REVISED 08.23.2024

# LUV

## PRODUCT INFORMATION

TABLES: STANDARD IN SOLID OAK

TABLES: UPCHARGE FOR MABLE OPTIONS

MARBLE - NERO MARQUINA / CARRARA / MARRON IMPERADOR / IMPERADOR LIGHT GRAY

ELEMENT 70: 2355

ELEMENT 71: 2734

ELEMENT 75: 6240

MARBLE - CALCATTA ORO

ELEMENT 70: 2938

ELEMENT 71: 3419

ELEMENT 75: 7800

ELEMENTS 70/71: DRAWER UPHOLSTERED IN LEATHER WW15900XX

ELEMENTE 76T/93T: LUMBAR CUSHION IS INCLUDED

PUSH BUTTONS: STANDARD VERSIONS COMES WITH 4 TOUCH BUTTONS (1 PER MOTOR)

RF CONTROL: REMOTE CONTROL WILL ALWAYS BE COMBINED WITH THE STANDARD 4 TOUCH BUTTONS

UPCHARGE FOR REMOTE: 649

BATTERY PACK : THE BATTERY PACK IS ALWAYS COMBINED WITH 8 BUTTONS (2 PER MOTOR). CHARGING IS DONE AT THE BACK OF THE SOFA AT THE BOTTOM VIA CABLE

UPCHARGE FOR BATTERY PACK: 824

BATTERY & RF CONTROL (REMOTE) CANNOT BE COMBINED\*\*



# LUV

## PRODUCT INFORMATION

### BATTERY PACK TECHNICAL INFORMATION

#### 1. SAFETY INSTRUCTIONS:

- Ambient temperature 0°C – 40°C
- Handle battery carefully!
  - Do not throw, drop or subject to strong vibrations
  - Do not expose to fire
  - Do not disassemble
  - Do not submerge in water
  - Keep away from children
  - Use in a dry, well-ventilated area

#### 2. INITIAL USE

Fully charge the battery before using it for the first time. Charging time is +/- 8 hours. The battery is fully charged when the green led turns on.

#### 3. LOAD

Charge the battery only with the supplied transformer.  
Flashing red LED light: the battery is charging  
Green LED light on permanently: battery fully charged  
Red LED light permanently on: battery defective

##### Attention:

- When charging the battery of your relax chair, always connect the battery (via the charging point) to the transformer first. Then connect the transformer to the mains.
- After charging, first disconnect the transformer from the mains, then from the battery.
- Charging should be done after the battery beeps, not before.
- The battery should be fully charged every three months. Otherwise, it will become defective and the warranty is void.
- Charging should only take place at an ambient temperature between 0 ° C and 40 ° C.
- An 8 hour charge time is recommended.
- If the battery is not fully charged after 24 hours, replace the battery.
- After 3 months of storage (not in use), fully charge the battery.

#### 4. MAINTENANCE

On regular basis:

- Remove dust and dirt with a slightly damp cloth
- Visual inspection for damage

#### 5. WARRANTY

Warranty battery and transformer = 2 years

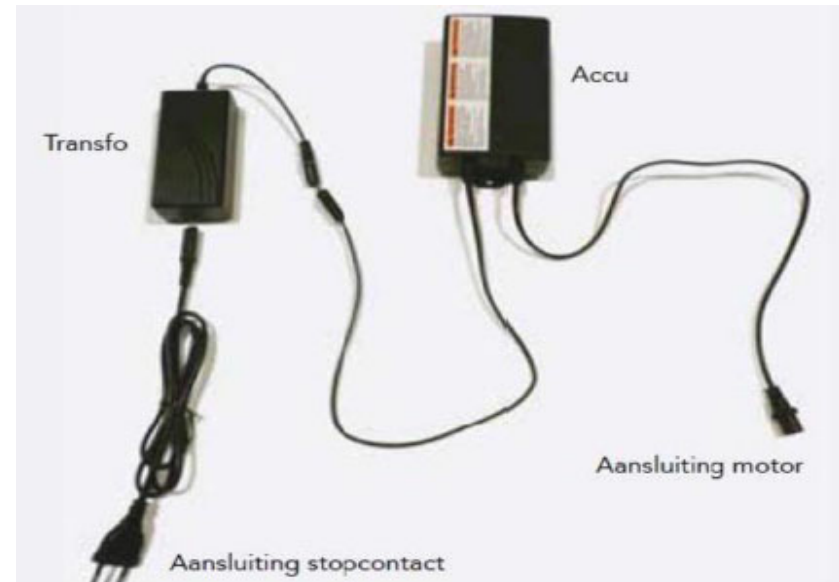

# LUV

## PRODUCT INFORMATION

### FINISH NOTES

### NOT AVAILABLE IN LEATHERS:

W401XX

W429XX

W477XX

# LUV

## PRODUCT INFORMATION

### WOOD FINISH OPTIONS FOR TABLE



NAI - Natural



OIL A



GMI



WEI - Wenge



MEI - Medium oak



ZAI - Grey oak (sand)



LEI - Loam oak oil



ZWI - Black



GRI - Grey oak matt lacquered



DGI - Dark Grey



TWI - Medium Brown

# LUV

## PRODUCT INFORMATION

### MARBLE FINISH OPTIONS FOR TABLE

**MAR-C**  
Carrara



**MAR-CALDO**  
Calacatta d'Oro



**MAR-MI**  
Marron  
Emperador



**MAR-NM**  
Nero Marquina



# LUV

## PRODUCT INFORMATION

DIMENSIONS IN CM

### ARMS

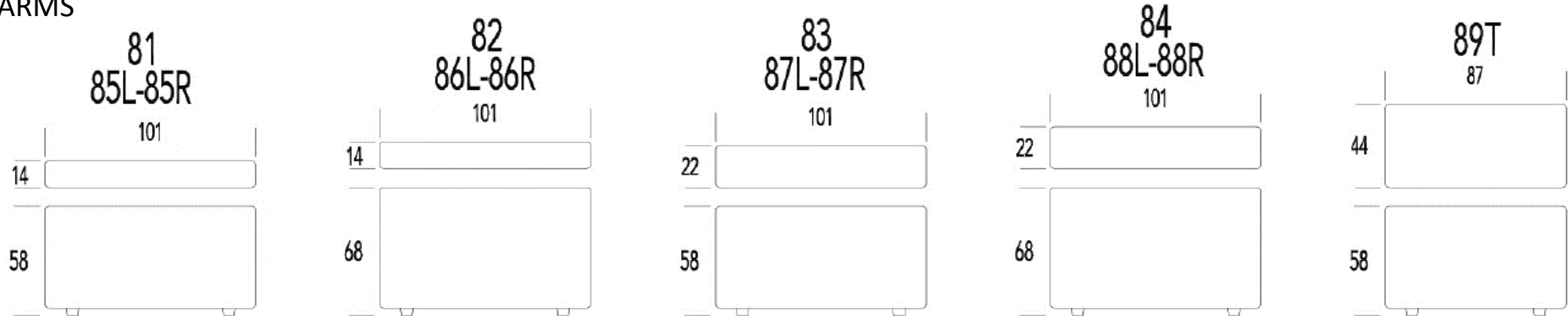

### BACK REST FOR FIXED SEATS

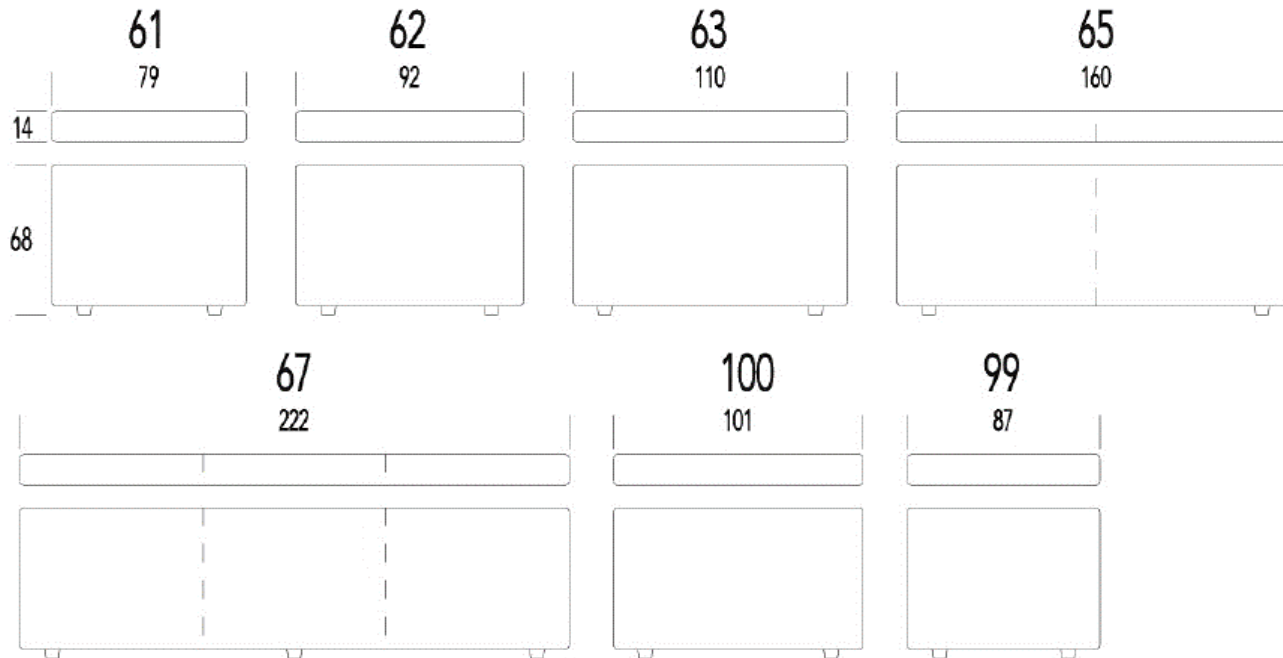

PRICING EFFECTIVE 10.01.2023

REVISED 08.23.2024

# LUV

## PRODUCT INFORMATION

DIMENSIONS IN CM

### FIXED SEATS

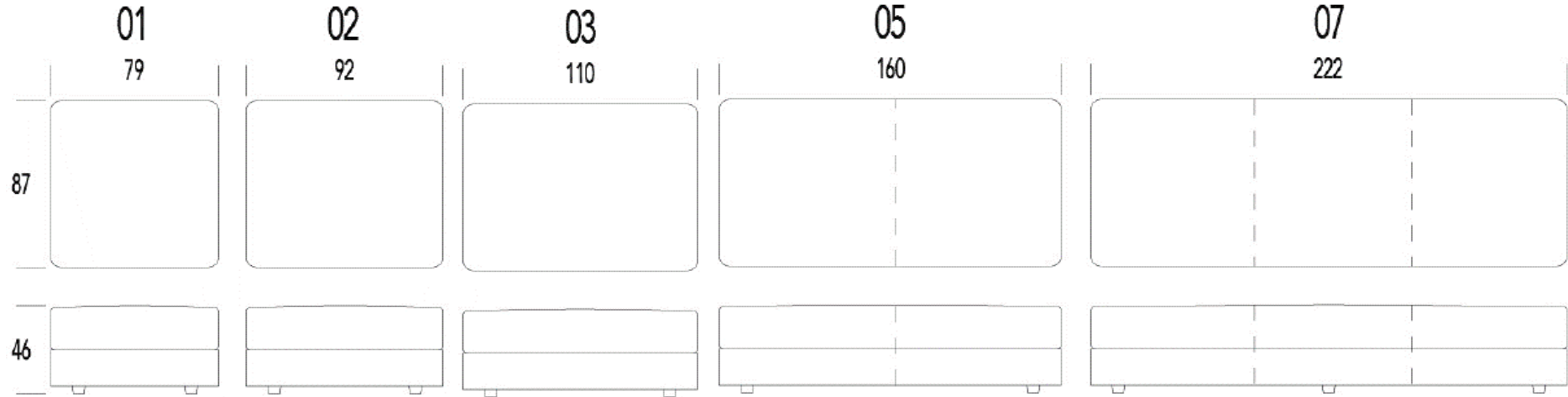

### MOTORIZED SEATS

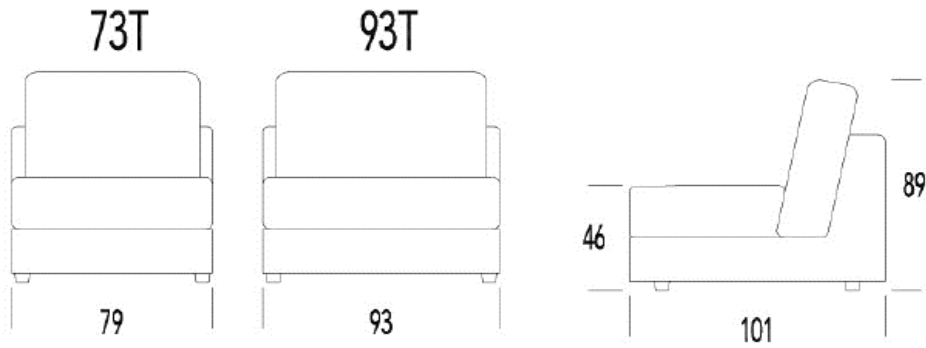

PRICING EFFECTIVE 10.01.2023

REVISED 08.23.2024



# LUV

## PRODUCT INFORMATION

DIMENSIONS IN CM

### BACK CUSHION

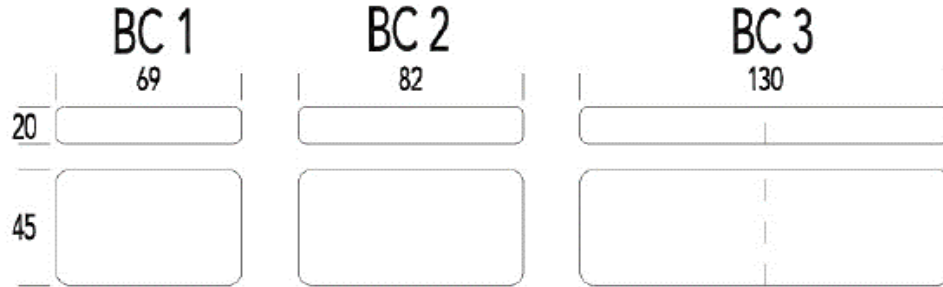

### LUMBAR PILLOW

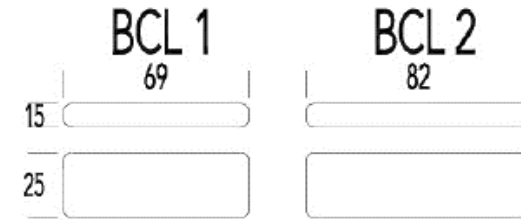

### TABLES

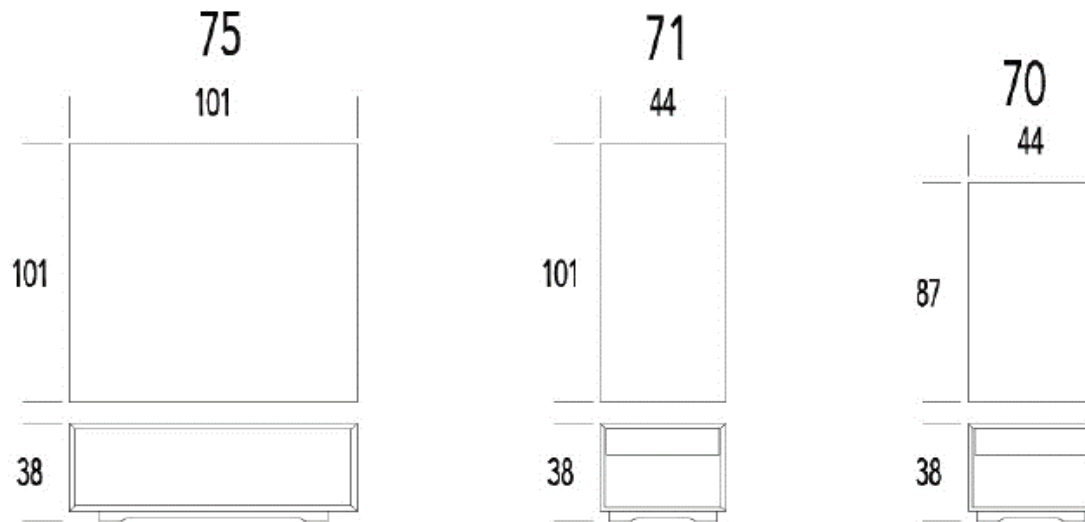

# LUV

## PRODUCT INFORMATION

DIMENSIONS IN CM

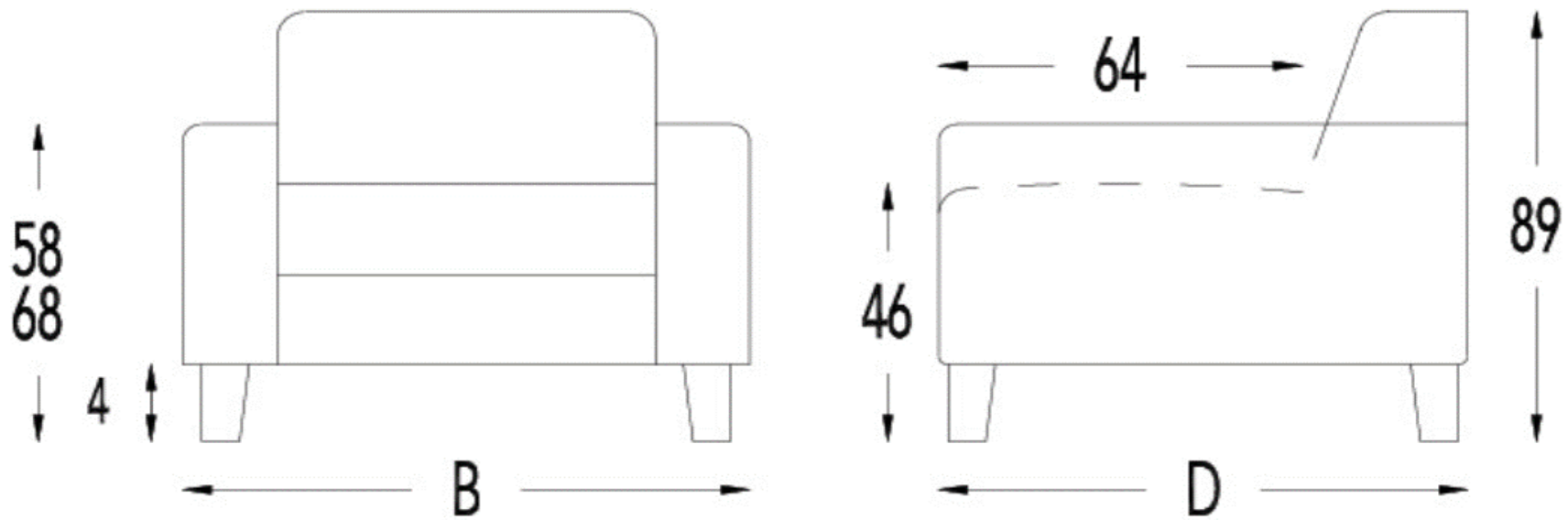

(Tolerance on dimensions  $\pm 3\%$ )

# LUV

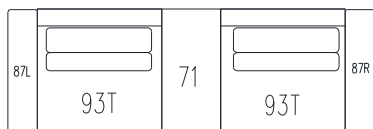

\*2 MOTION SEATS\*

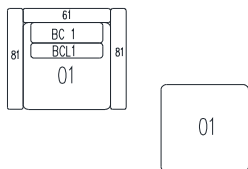

\*STATIONARY SEAT & OTTOMAN\*

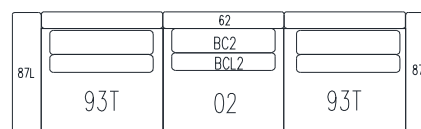

\*2 MOTION SEATS, MIDDLE SEAT IS FIXED\*

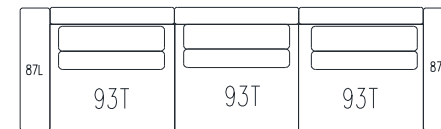

\*3 MOTION SEATS\*

<b>W:</b>	108"	41 1/2"	126 3/4"	126 3/4"
<b>H:</b>	26 3/4"	26 3/4"	26 3/4"	26 3/4"
<b>D:</b>	40"	40"	40"	40"

Article Code	Predesigned A	Predesigned B	Predesigned C	Predesigned D
<b>Description</b>	87L + 93T + 71 + 93T + 87R	81 + 01 + 61 + BC1 + BCL1 + 81 + 01	87L + 93T + 02 + 62 + BC2 + BCL2 + 93T + 87R	87L + 93T + 93T + 93T + 87R

<b>COM Yardage</b>	16.51	14.83	25.35	22.93
--------------------	-------	-------	-------	-------

Fabric	Retail			
COM	25509	11948	28763	32116
ST03	25509	11948	28763	32116
ST05	26323	12814	30049	33238
ST06	26730	13247	30699	33796
ST07	27176	13706	31401	34399
ST08	27556	14191	32077	34918
ST09	27950	14533	32667	35469

<b>COL Sqft</b>	304.40	260.81	448.21	420.65
-----------------	--------	--------	--------	--------

Leather	Retail			
COL	29170	18220	35659	36709
W4	31175	19617	38411	39548
W6	34143	21704	42509	43755
WW11	40114	26664	51058	52094
WW15	43303	29013	55401	56503

<b>REMOTE CONTROL UPCHARGE (PER SEAT):</b>	<b>649</b>
--------------------------------------------	------------

**\*NOT AVAILABLE IN LEATHERS: W401XX, W429XX, W477XX\***

# LUV

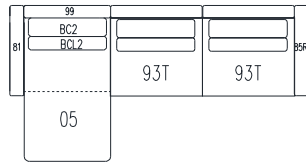

\*2 MOTION SEATS\*

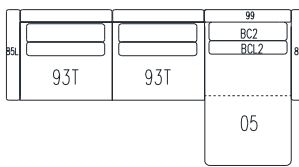

\*2 MOTION SEATS\*

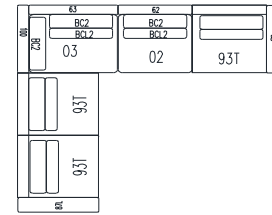

\*3 MOTION SEATS\*

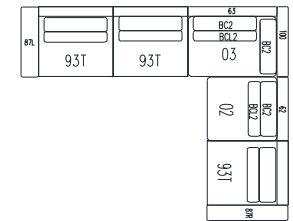

\*3 MOTION SEATS\*

<b>W:</b>	118 1/2"	118 1/2"	131 1/4"	131 1/4"
<b>H:</b>	26 3/4"	26 3/4"	26 3/4"	26 3/4"
<b>D:</b>	68 1/2"	68 1/2"	121 5/8"	121 5/8"

Article Code	Predesigned E	Predesigned F	Predesigned G	Predesigned H
<b>Description</b>	85R + 93T + 93T + 05 + 99 + BC2 + BCL2 + 81	85L + 93T + 93T + 05 + 99 + BC2 + BCL2 + 81	87L + 93T + 93T + 03 + 100 + 63 + BC2 + BC2 + BCL2 + 02 + 62 + BC2 + BCL2 + 93T + 87R	87L + 93T + 93T + 03 + 100 + 63 + BC2 + BC2 + BCL2 + 02 + 62 + BC2 + BCL2 + 93T + 87R

COM Yardage	26.80	26.80	45.49	45.49
-------------	-------	-------	-------	-------

Fabric	Retail			
COM	30154	30154	48414	48414
ST03	30154	30154	48414	48414
ST05	31598	31598	50677	50677
ST06	32293	32293	51845	51845
ST07	33035	33035	53078	53078
ST08	33704	33704	54286	54286
ST09	34406	34406	55368	55368

COL Sqft	483.51	483.51	791.36	791.36
----------	--------	--------	--------	--------

Leather	Retail			
COL	37319	37319	60053	60053
W4	40197	40197	64684	64684
W6	44503	44503	72027	72027
WW11	53498	53498	86120	86120
WW15	57993	57993	96197	96197

<b>REMOTE CONTROL UPCHARGE (PER SEAT):</b>	<b>649</b>
--------------------------------------------	------------

**\*NOT AVAILABLE IN LEATHERS: W401XX, W429XX, W477XX\***

\*\*BATTERY PACK IS NOT APPLICABLE WITH A REMOTE CONTROL \*\*

# LUV

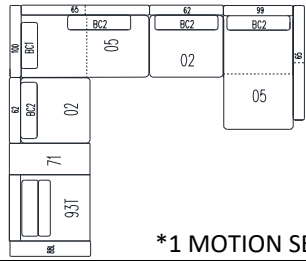

\* 1 MOTION SEAT\*

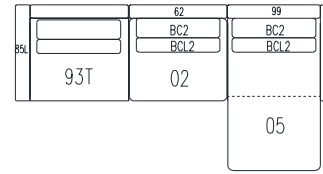

\* 1 MOTION SEAT\*

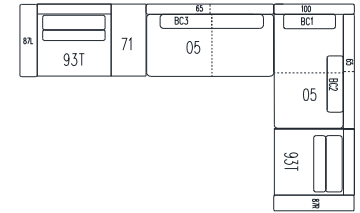

\* 2 MOTION SEATS\*

<b>W:</b>	144 1/2"	117 3/4"	165"
<b>H:</b>	26 3/4"	26 3/4"	26 3/4"
<b>D:</b>	139"	68 1/2"	110 1/4"

Article Code	Predesigned I	Predesigned J	Predesigned K
<b>Description</b>	88L + 93T + 71 + 62 + 02 + BC2 + 100 + 05 + 65 + BC1 + BC2 + 93T + 05 + 99 + 65 + BC2	85L + 93T + 02 + 62 + BC2 + BCL2 + 05 + 99 + 81 + BC2 + BCL2	87L + 93T + 71 + 05 + 65 + BC3 + 05 + 100 + 65 + BC1 + BC2 + 93T + 87R

<b>COM Yardage</b>	52.46	29.22	43.68
--------------------	-------	-------	-------

Fabric	Retail		
COM	50579	26802	44674
ST03	50579	26802	44674
ST05	53256	28409	46996
ST06	54601	29196	48158
ST07	56018	30036	49398
ST08	57481	30863	50625
ST09	58773	31604	51806

<b>COL Sqft</b>	920.53	511.07	798.04
-----------------	--------	--------	--------

Leather	Retail		
COL	67211	36269	59088
W4	72371	39060	63426
W6	79500	43257	69816
WW11	95725	52462	83889
WW15	103355	56890	90653

<b>REMOTE CONTROL UPCHARGE (PER SEAT):</b>	<b>649</b>
--------------------------------------------	------------

**\*NOT AVAILABLE IN LEATHERS: W401XX, W429XX, W477XX\***

# LUV

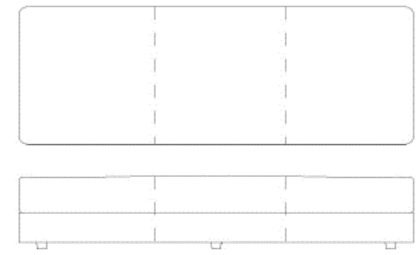
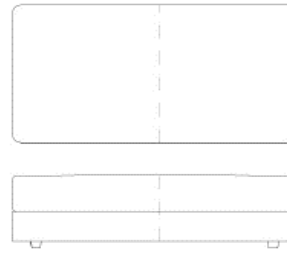
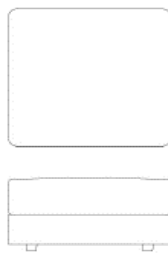

<b>W:</b>	30 3/4"	36 1/4"	43 3/8"	63"	87 1/2"
<b>H:</b>	18 1/8"	18 1/8"	18 1/8"	18 1/8"	18 1/8"
<b>D:</b>	34 1/4"	34 1/4"	34 1/4"	34 1/4"	34 1/4"

Article Code	01	02	03	05	07
Description	Fixed Seat	Fixed Seat	Fixed Seat	Fixed Seat	Fixed Seat

COM Yardage	3.74	4.13	4.66	6.10	6.10
-------------	------	------	------	------	------

Fabric	Retail				
COM	3641	3989	4980	5636	7893
ST03	3641	3989	4980	5636	7893
ST05	3878	4258	5288	6036	8405
ST06	4009	4396	5446	6233	8680
ST07	4133	4534	5603	6436	8949
ST08	4258	4678	5761	6613	9225
ST09	4363	4790	5911	6823	9481

COL Sqft	69.53	76.64	86.33	121.09	157.80
----------	-------	-------	-------	--------	--------

Leather	Retail				
COL	5301	5806	6797	8168	10642
W4	5701	6255	7326	8799	11460
W6	6312	6922	8109	9743	12689
WW11	7775	8529	9960	12066	15595
WW15	8392	9218	10773	13030	16855

\*NOT AVAILABLE IN LEATHERS: W401XX, W429XX , W477XX\*

# LUV

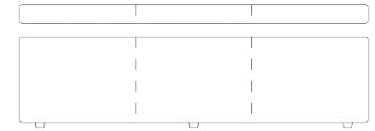
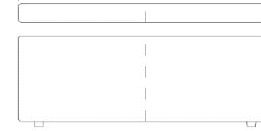
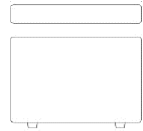

<b>W:</b>	30 3/4"	34 1/4"	36 1/4"	39 3/4"	43 3/8"	63"	87 1/2"
<b>H:</b>	26 3/4"	26 3/4"	26 3/4"	26 3/4"	26 3/4"	26 3/4"	26 3/4"
<b>D:</b>	5 1/2"	5 1/2"	5 1/2"	5 1/2"	5 1/2"	5 1/2"	5 1/2"

<b>Article Code</b>	<b>61</b>	<b>99</b>	<b>62</b>	<b>100</b>	<b>63</b>	<b>65</b>	<b>67</b>
<b>Description</b>	Back for Fixed Seat	Back for Fixed Seat	Back for Fixed Seat	Back for Fixed Seat	Back for Fixed Seat	Back for Fixed Seat	Back for Fixed Seat

<b>COM Yardage</b>	2.14	2.33	2.45	2.69	2.92	4.12	5.61
--------------------	------	------	------	------	------	------	------





<b>Fabric</b>	<b>Retail</b>						
COM	1266	1279	1312	1378	1397	1844	2034
ST03	1266	1279	1312	1378	1397	1844	2034
ST05	1332	1345	1378	1443	1483	2034	2191
ST06	1358	1378	1411	1496	1529	2126	2264
ST07	1397	1411	1443	1535	1575	2224	2342
ST08	1443	1443	1502	1575	1607	2329	2434
ST09	1470	1483	1516	1607	1653	2434	2513

<b>COL Sqft</b>	26.05	32.40	34.01	37.14	48.01	67.81	115.17
-----------------	-------	-------	-------	-------	-------	-------	--------

<b>Leather</b>	<b>Retail</b>						
COL	1850	1548	1922	1666	1778	3668	3871
W4	2005	1662	2070	1801	1910	3958	4170
W6	2211	1844	2290	1988	2546	4370	4612
WW11	2736	2224	2847	2414	2756	5413	5892
WW15	2966	2414	3084	2624	5859	5859	6377

**\*NOT AVAILABLE IN LEATHERS: W401XX, W429XX , W477XX\***

# LUV

				
<b>W:</b> 5 1/2	5 1/2	8 1/2	8 1/2	17 1/2
<b>H:</b> 22 7/8"	26 3/4"	22 7/8"	26 3/4"	22 7/8"
<b>D:</b> 40"	40"	40"	40"	34 1/4"

Article Code	81	82	83	84	89T
<b>Description</b>	Low Narrow Armrest for Fixed Seating	High Narrow Armrest for Fixed Seating	Low Wide Armrest for Fixed Seating	High Wide Armrest for Fixed Seating	Low Wedge Arm In Between Fixed Seating

<b>COM Yardage</b>	1.64	2.73	1.84	2.92	2.23
--------------------	------	------	------	------	------

Fabric	Retail				
COM	1155	1397	1266	1483	1621
ST03	1155	1397	1266	1483	1621
ST05	1266	1516	1365	1607	1745
ST06	1312	1575	1417	1666	1798
ST07	1365	1640	1483	1745	1857
ST08	1411	1712	1535	1811	1935
ST09	1443	1745	1575	1844	1988

<b>COL Sqft</b>	32.18	37.14	35.95	41.12
-----------------	-------	-------	-------	-------

Leather	Retail				
COL	2001	2408	2165	2552	2933
W4	2158	2588	2333	2748	3157
W6	2388	2867	2578	3051	3497
WW11	2959	3563	3195	3766	4245
WW15	3294	3969	3569	4192	4967

\*NOT AVAILABLE IN LEATHERS: W401XX, W429XX, W477XX\*



# LUV

DEPTH W/ RECLINER:  
69 3/4"

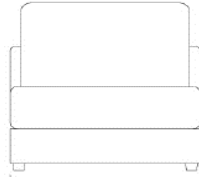

<b>W:</b>	31 1/8"	36 5/8"	39 3/4"	17 3/8"	17 3/8"
<b>H:</b>	35"	35"	15"	15"	15"
<b>D:</b>	40"	40"	40"	40"	34 1/4"

<b>Article Code</b>	<b>73T</b>	<b>93T</b>	<b>75</b>	<b>71</b>	<b>70</b>
<b>Description</b>	Motorized Reclining Armless Single Seat	Motorized Reclining Armless Single Seat	Table	Table w/ Drawer	Table w/ Drawer

<b>COM Yardage</b>	5.75	6.42	-	-	-
--------------------	------	------	---	---	---

<b>Fabric</b>	<b>Retail</b>				
COM	9376	9861	4311	3254	3071
ST03	9376	9861	4311	3254	3071
ST05	9671	10170	4311	3254	3071
ST06	9815	10320	4311	3254	3071
ST07	9960	10478	4311	3254	3071
ST08	10097	10616	4311	3254	3071
ST09	10235	10773	4311	3254	3071

<b>COL Sqft</b>	103.44	116.25	-	-	-
-----------------	--------	--------	---	---	---

<b>Leather</b>	<b>Retail</b>				
COL	10261	10793	4311	3254	3071
W4	11044	11628	4311	3254	3071
W6	12223	12866	4311	3254	3071
WW11	14474	15235	4311	3254	3071
WW15	15641	16455	4311	3254	3071

<b>REMOTE CONTROL UPCHARGE (PER SEAT):</b>	<b>649</b>
--------------------------------------------	------------

**\*NOT AVAILABLE IN LEATHERS: W401XX, W429XX, W477XX\***

**\*\*BATTERY PACK IS NOT APPLICABLE WITH A REMOTE CONTROL \*\***

# LUV



<b>W:</b>	5 1/2"	5 1/2"	8 5/8"	8 5/8"
<b>H:</b>	22 7/8"	26 3/4"	22 7/8"	26 3/4"
<b>D:</b>	40"	40"	40"	40"

Article Code	85L/85R	86L/86R	87L/87R	88L/88R
<b>Description</b>	<b>85L</b> = Left Low Narrow Armrest for Reclining Seating <b>85R</b> = Right Low Narrow Armrest for Reclining Seating	<b>86L</b> = Left High Narrow Armrest for Reclining Seating <b>86R</b> = Right High Narrow Armrest for Reclining Seating	<b>87L</b> = Left Low Armrest for Reclining Seating <b>87R</b> = Right Low Armrest for Reclining Seating	<b>88L</b> = Left High Armrest for Reclining Seating <b>88R</b> = Right High Armrest for Reclining Seating

<b>COM Yardage</b>	1.64	2.73	1.84	2.92
--------------------	------	------	------	------

Fabric	Retail			
COM	1155	1397	1266	1483
ST03	1155	1397	1266	1483
ST05	1266	1516	1365	1607
ST06	1312	1575	1417	1666
ST07	1365	1640	1483	1745
ST08	1411	1712	1535	1811
ST09	1443	1745	1575	1844

<b>COL Sqft</b>	32.18	37.14	35.95	
-----------------	-------	-------	-------	--

Leather	Retail			
COL	2001	2408	2165	2552
W4	2158	2588	2333	2748
W6	2388	2867	2578	3051
WW11	2959	3563	3195	3766
WW15	3294	3969	3569	4192

**\*NOT AVAILABLE IN LEATHERS: W401XX, W429XX , W477XX\***

# LUV

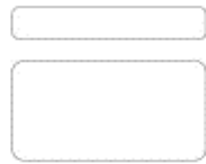

<b>W:</b>	27 1/8"	32 1/4"	51 1/4"	27 1/8"	32 1/4"
<b>H:</b>	17 3/4"	17 3/4"	17 3/4"	9 7/8"	9 7/8"
<b>D:</b>	7 7/8"	7 7/8"	7 7/8"	6"	6"

Article Code	BC1	BC2	BC3	BCL1	BCL2
<b>Description</b>	Back Cushion	Back Cushion	Back Cushion	Lumbar Pillow	Lumbar Pillow

COM Yardage	1.04	1.20	1.78	0.89	0.89
-------------	------	------	------	------	------

Fabric	Retail				
COM	722	827	1279	367	381
ST03	722	827	1279	367	381
ST05	794	899	1397	400	446
ST06	827	938	1450	420	479
ST07	866	984	1516	446	518
ST08	932	1056	1621	479	538
ST09	951	1089	1693	499	577

COL Sqft	22.07	22.28	34.34	9.26	10.87
----------	-------	-------	-------	------	-------

Leather	Retail				
COL	1168	1345	2067	597	669
W4	1261	1443	2231	634	722
W6	1391	1601	2467	702	807
WW11	1634	1876	2893	827	945
WW15	1778	2034	3136	899	1017

**\*NOT AVAILABLE IN LEATHERS: W401XX, W429XX , W477XX\***