

SLIDING COLLECTION

BY ALEAL



PLANUM[®]
FURNITURE

Swedesford Corporate Center
619 B Swedesford Road
Frazer, PA 19355

Email: info@planumfurniture.com
Website: planumfurniture.com

Tel : 610/251-2120
Tel : 800/343-0042
Fax : 610/251-2290

ALEAL Finishes

LACQUER FINISHES



LC01 BLACK



LC02 WHITE



LC07 BRICK RED



LC11 TOMATO RED



LC12 SLATE GRAY

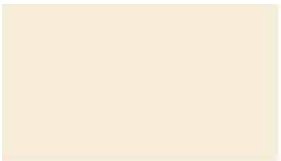

LC13 IVORY



LC14 METALLIC
GRAY



LC15 GRAY BEIGE



LC16 FOG GRAY



LC18 METALLIC
TAUPE



LC19 CAMOUFLAGE



LC20 GUN
METAL GRAY



LC21 MUSTARD
YELLOW



LC22 ASH GRAY



LC23 SILVER
GRAY



LC26 BURGANDY



LC27 RUBY



LC28 CAPPUCCINO

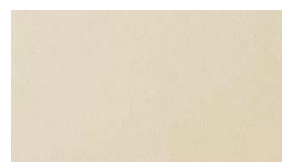

LC36 PEARL

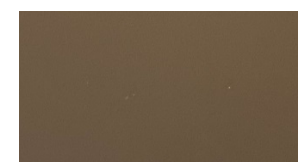

LC37 PEWTER



LC38 PALOMINO



LC39 PETROL BLUE



BRONZE



SILVER



GOLD



CHAMPAGNE

PLEASE NOTE ABOVE LACQUERS ARE AVAILABLE IN THE BELOW SHEENS:

5% MATTE OR 30% SEMIGLOSS - USE MATTE PRICING

100% SHEEN - USE HIGH GLOSS PRICING

ALEAL Finishes

OAK & WALNUT FINISHES



BLACK OAK CV01



CHOCOLATE OAK
CV02



SLATE GRAY OAK
CV03



IVORY OAK CV12



METALLIC TAUPE
OAK CV11



METALLIC GRAY
OAK CV10



OPAL GRAY OAK
CVL15



GRAY BEIGE OAK
CV09



WHITE OAK CV04



CHERRY OAK CV05



NATURAL OAK CV06



STEEL GRAY OAK
CVL14



SMOOTH CHOCOLATE
OAK CVL16



CVL19



RUSTIC OAK CVL17



WILD OAK CV06



WALNUT NG01

PLEASE NOTE ABOVE WOODS ARE AVAILABLE IN THE BELOW SHEENS:

5% MATTE OR 30% SEMIGLOSS - USE MATTE PRICING

*THEY ARE NOT AVAILABLE IN 100% SHEEN HIGH GLOSS**

ALEAL Finishes

EBONY



RECONSTITUTED
EBONY



NATURAL EBONY

ROSEWOOD



RECONSTITUTED
ROSEWOOD

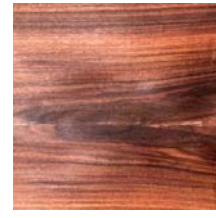

NATURAL
ROSEWOOD

EUCALYPTUS FRISE



GREY EUCALYPTUS

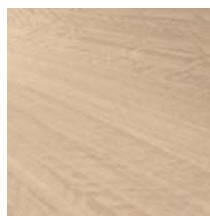

POLAR EUCALYPTUS

PLAIN STAINED EUCALYPTUS

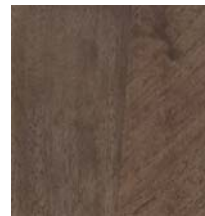

SOFT PLUM



ARGENTO



ESPRESSO EUCALYPTUS

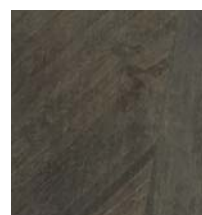

SOFT GREY

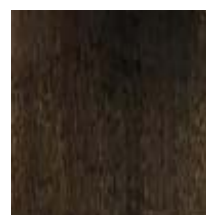

TOFFEE

TULIP WOOD



OAK FUME



ASH BURL



BURGANDY



LIGHT GRAY

PLEASE NOTE ABOVE WOODS ARE AVAILABLE IN THE BELOW SHEENS:

5% MATTE OR 30% SEMIGLOSS - USE MATTE PRICING

100% SHEEN - USE HIGH GLOSS PRICING

ALEAL Finishes

STAINLESS STEEL



POLISHED STAINLESS
STEEL



BRUSHED STAINLESS
STEEL

BRASS



BRUSHED BRASS



BRUSHED ANTIQUE BRASS

POLISHED PLATED STAINLESS STEEL



COPPER



NICKEL NOIR



GOLD

CERAMIC FINISHES



ARENA



ARTIC WHITE



AVORIO



BARRO



BASALT BEIGE



BASALT BLACK



BELGIAN BLUE



BASALT GREY



CEMENT



IRON COPPER



IRON CORTEN



IRON GREY



IRON MOSS



LAVA



PERLA

ALEAL Finishes

CERAMIC FINISHES (MARBLE IMITATIONS w/ GLOSS FINISH)



SILK GRISS



CARRARA
POLIDO

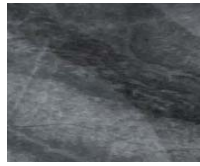

MEDUSA



ESTUARIO POLIDO

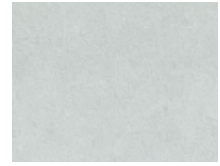

CALCATA



SILK GRIS
NATURAL



ONICE BEJE
(MATTE FINISH)

PLEASE NOTE :

The above ceramic finishes cannot be applied to Extension tables -- they are too thick (5.6 MM).

CERAMIC FINISHES (MARBLE IMITATIONS w/ MATTE FINISH)



THUNDER
LIGHT



CALCATA MIX

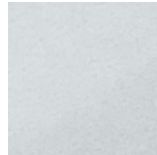

ESTUARIO



CARRARA
NATURAL



TEMPO SMOKE



SUPREME
NATURAL

PLEASE NOTE :

Special Pricing for Marble Imitation Ceramics - Must Get Quote

TABLE OF CONTENTS

	<u>PAGE #</u>
DINING TABLE	8
SIDEBOARD	8-9
VITRINE	9-10
BAR	10
MEDIA	11-14
WALL MODULE	14
PREDESIGNED CONFIGURATION	15-18
OCCASIONAL	18

DINING TABLE

Description		Dimensions in Inches		
Item No.	Finish	W	H	D



2 vol. / 0,338 m3 / 85 Kg

SLIDING Rectangular Extension Dining Table

Lacquer Top
Accent Legs & Extension

74 7/8" 30 3/4" 39 3/8"
2x 21 5/8" Extension Leaves

FINISH OPTIONS		
SLIDIN-802/1	Eucalyptus Frise, Ash Burl or Natural Rosewood	
SLIDIN-802/2	Tulip Wood	
SLIDIN-802/3	Reconstituted Ebony, Oak Fume or Reconstituted Rosewood	
SLIDIN-802/4	Natural Ebony	
SLIDIN-802/5	Eucalyptus Stain	
SLIDIN-802/6	Oak (5% or 30% Sheen)	
SLIDIN-802/7	Walnut (5% or 30% Sheen)	
SLIDIN-802/8	All Lacquer	

UPCHARGE	Ceramic Top	
----------	-------------	--

Available at 63"x 39 3/8" w/ 2x 15 3/4" Extensions-- Same price as above

SLIDING Square Extension Dining Table

Lacquer Top
Accent Legs & Extension

55 1/8" 30 3/4" 55 1/8"
1x 25 5/8" Extension Leafs



2 vol. / 0,350 m3 / 85 Kg

FINISH OPTIONS		
SLIDIN-804/1	Eucalyptus Frise, Ash Burl or Natural Rosewood	
SLIDIN-804/2	Tulip Wood	
SLIDIN-804/3	Reconstituted Ebony, Oak Fume or Reconstituted Rosewood	
SLIDIN-804/4	Natural Ebony	
SLIDIN-804/5	Eucalyptus Stain	
SLIDIN-804/6	Oak (5% or 30% Sheen)	
SLIDIN-804/7	Walnut (5% or 30% Sheen)	
SLIDIN-804/8	All Lacquer	

UPCHARGE	Ceramic Top	
----------	-------------	--

SIDEBOARD

SLIDING Sideboard (Big Version)

2x Touch Latch Doors
2x Interior Lacquer Shelves & 1x Tempered Glass Shelf
Matte Lacquer Structure/ HG Lacquer Fronts
Accent Top & Plinth

94 1/2" 31" 21 5/8"

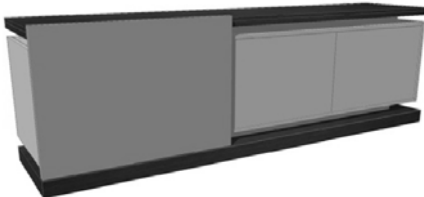

2 vol. / 1,229 m3 / 162 Kg

FINISH OPTIONS		
SLIDIN-800/1	Eucalyptus Frise, Ash Burl or Natural Rosewood	
SLIDIN-800/2	Tulip Wood	
SLIDIN-800/3	Reconstituted Ebony, Oak Fume or Reconstituted Rosewood	
SLIDIN-800/4	Natural Ebony	
SLIDIN-800/5	Eucalyptus Stain	
SLIDIN-800/6	Oak (5% or 30% Sheen)	
SLIDIN-800/7	Walnut (5% or 30% Sheen)	
SLIDIN-800/8	All Lacquer	

UPCHARGE	Cutlery Insert	
----------	----------------	--

UPCHARGE	LED Lights	
----------	------------	--

DINING TABLE

Description		Dimensions in Inches		
Item No.	Finish	W	H	D



2 vol. / 1,033 m3 / 136 Kg

SLIDING Sideboard (Small Version)

2x Touch Latch Doors
 2x Interior Lacquer Shelves & 1x Tempered Glass Shelf
 Matte Lacquer Structure/ HG Lacquer Fronts
 Accent Top & Plinth

78 3/4" 31" 21 5/8"

FINISH OPTIONS

SLIDIN-815/1	Eucalyptus Frise, Ash Burl or Natural Rosewood
SLIDIN-815/2	Tulip Wood
SLIDIN-815/3	Reconstituted Ebony, Oak Fume or Reconstituted Rosewood
SLIDIN-815/4	Natural Ebony
SLIDIN-815/5	Eucalyptus Stain
SLIDIN-815/6	Oak (5% or 30% Sheen)
SLIDIN-815/7	Walnut (5% or 30% Sheen)
SLIDIN-815/8	All Lacquer

UPCHARGE	Cutlery Insert
UPCHARGE	LED Lights

VITRINE

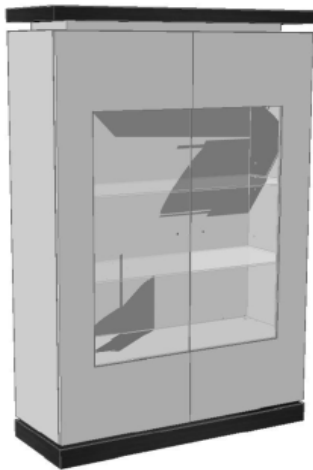

2 vol. / 1.094 m3 / 139 kg

SLIDING Vitrine

2x Touch Latch Doors
 2x Interior Lights, Mirrored Back
 2x Interior Glass Shelves & 2x Lacquer Shelves
 Matte Lacquer Structure/ HG Lacquer Fronts
 Accent Top & Plinth

47 1/4" 74 7/8" 17 3/8"

FINISH OPTIONS

SLIDIN-816/1	Eucalyptus Frise, Ash Burl or Natural Rosewood
SLIDIN-816/2	Tulip Wood
SLIDIN-816/3	Reconstituted Ebony, Oak Fume or Reconstituted Rosewood
SLIDIN-816/4	Natural Ebony
SLIDIN-816/5	Eucalyptus Stain
SLIDIN-816/6	Oak (5% or 30% Sheen)
SLIDIN-816/7	Walnut (5% or 30% Sheen)
SLIDIN-816/8	All Lacquer

UPCHARGE	LED Lights (for the Top)
----------	--------------------------

*** RECOMMENDED THAT UNIT BE ATTACHED TO WALL ***

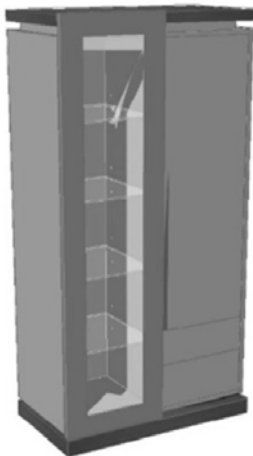

SLIDING B Vitrine

1x Sliding Glass Door & 1x Touch Latch Door
 2x Drawers
 4x Glass Shelves
 Interior Light
 Matte Lacquer Structure/ HG Lacquer Fronts
 Accent Top & Plinth

39 3/8" 82 5/8" 21 5/8"

FINISH OPTIONS

SLIDIN-820/1	Eucalyptus Frise, Ash Burl or Natural Rosewood
SLIDIN-820/2	Tulip Wood
SLIDIN-820/3	Reconstituted Ebony, Oak Fume or Reconstituted Rosewood
SLIDIN-820/4	Natural Ebony
SLIDIN-820/5	Eucalyptus Stain
SLIDIN-820/6	Oak (5% or 30% Sheen)
SLIDIN-820/7	Walnut (5% or 30% Sheen)
SLIDIN-820/8	All Lacquer

UPCHARGE	LED Lights (for the Top)
----------	--------------------------

*** RECOMMENDED THAT UNIT BE ATTACHED TO WALL ***

VITRINE	Description		Dimensions in Inches		
	Item No.	Finish	W	H	D

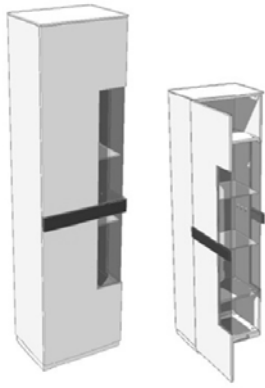

STRIPES 1 Door Vitrine
 2x Interior Lacquer Shelves & 2x Glass Shelves
 Matte Lacquer Structure/ Lacquer Fronts

23 5/8" 80 3/8" 17 3/4"

STRIPES-728	All Lacquer
--------------------	-------------

*** RECOMMENDED THAT UNIT BE ATTACHED TO WALL ***

*** MIRROR IMAGE AVAILABLE ***

2 vol. / 0,637 m3 / 75 Kg

BAR



SLIDING Bar Unit
 1x Sliding Door & 2x Touch Latch Door
 1x Drawer
 Interior Lights & 3x Glass Shelves
 Matte Lacquer Structure/ HG Lacquer Fronts
 Accent Top & Plinth

47 1/4" 57" 21 5/8"

FINISH OPTIONS	
SLIDIN-801/1	Eucalyptus Frise, Ash Burl or Natural Rosewood
SLIDIN-801/2	Tulip Wood
SLIDIN-801/3	Reconstituted Ebony, Oak Fume or Reconstituted Rosewood
SLIDIN-801/4	Natural Ebony
SLIDIN-801/5	Eucalyptus Stain
SLIDIN-801/6	Oak (5% or 30% Sheen)
SLIDIN-801/7	Walnut (5% or 30% Sheen)
SLIDIN-801/8	All Lacquer

*** RECOMMENDED THAT UNIT BE ATTACHED TO WALL ***

2 vol. / 0,957 m3 / 140 Kg

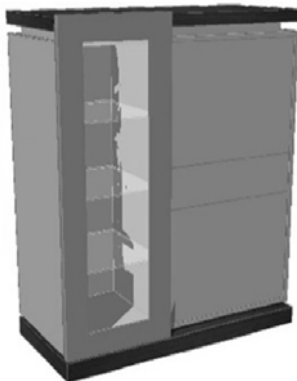

SLIDING Bar Unit w/ Glass Door
 1x Sliding Glass Door & 2x Touch Latch Door
 1x Drawer
 Interior Lights & 3x Glass Shelves
 Matte Lacquer Structure/ HG Lacquer Fronts
 Accent Top & Plinth

47 1/4" 57" 21 5/8"

FINISH OPTIONS	
SLIDIN-819/1	Eucalyptus Frise, Ash Burl or Natural Rosewood
SLIDIN-819/2	Tulip Wood
SLIDIN-819/3	Reconstituted Ebony, Oak Fume or Reconstituted Rosewood
SLIDIN-819/4	Natural Ebony
SLIDIN-819/5	Eucalyptus Stain
SLIDIN-819/6	Oak (5% or 30% Sheen)
SLIDIN-819/7	Walnut (5% or 30% Sheen)
SLIDIN-819/8	All Lacquer

*** RECOMMENDED THAT UNIT BE ATTACHED TO WALL ***

MEDIA	Description		Dimensions in Inches		
	Item No.	Finish	W	H	D

SLIDING TV Unit
 1x Sliding Door
 2x Drawers
 1x Tempered Glass Shelf
 Matte Lacquer Structure/ HG Lacquer Fronts
 Accent Top & Plinth

114 1/4" 25 3/4" 21 5/8"

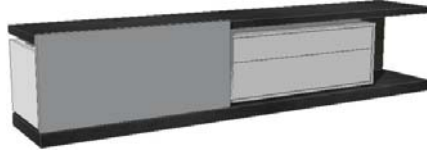

3 vol. / 1.211 m3 / 164 kg

FINISH OPTIONS		
SLIDIN-827/1	Eucalyptus Frise, Ash Burl or Natural Rosewood	
SLIDIN-827/2	Tulip Wood	
SLIDIN-827/3	Reconstituted Ebony, Oak Fume or Reconstituted Rosewood	
SLIDIN-827/4	Natural Ebony	
SLIDIN-827/5	Eucalyptus Stain	
SLIDIN-827/6	Oak (5% or 30% Sheen)	
SLIDIN-827/7	Walnut (5% or 30% Sheen)	
SLIDIN-827/8	All Lacquer	

UPCHARGE	LED Lights	
----------	------------	--

SLIDING Media Cabinet (Big Version)
 1x Sliding Door
 2x Touch Latch Doors
 2x Interior Lacquer Shelves
 Matte Lacquer Structure/ HG Lacquer Fronts
 Accent Top & Plinth

94 1/2" 22 7/8" 21 5/8"

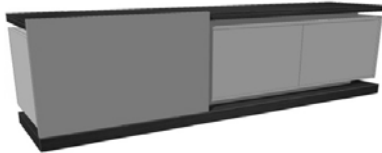

FINISH OPTIONS		
SLIDIN-817/1	Eucalyptus Frise, Ash Burl or Natural Rosewood	
SLIDIN-817/2	Tulip Wood	
SLIDIN-817/3	Reconstituted Ebony, Oak Fume or Reconstituted Rosewood	
SLIDIN-817/4	Natural Ebony	
SLIDIN-817/5	Eucalyptus Stain	
SLIDIN-817/6	Oak (5% or 30% Sheen)	
SLIDIN-817/7	Walnut (5% or 30% Sheen)	
SLIDIN-817/8	All Lacquer	

UPCHARGE	LED Lights	
----------	------------	--

SLIDING Media Cabinet (Small Version)
 1x Sliding Door
 2x Touch Latch Doors
 2x Interior Lacquer Shelves
 Matte Lacquer Structure/ HG Lacquer Fronts
 Accent Top & Plinth

78 3/4" 22 7/8" 21 5/8"

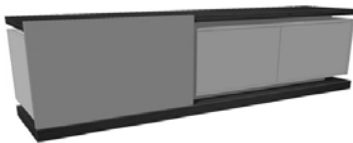

FINISH OPTIONS		
SLIDIN-818/1	Eucalyptus Frise, Ash Burl or Natural Rosewood	
SLIDIN-818/2	Tulip Wood	
SLIDIN-818/3	Reconstituted Ebony, Oak Fume or Reconstituted Rosewood	
SLIDIN-818/4	Natural Ebony	
SLIDIN-818/5	Eucalyptus Stain	
SLIDIN-818/6	Oak (5% or 30% Sheen)	
SLIDIN-818/7	Walnut (5% or 30% Sheen)	
SLIDIN-818/8	All Lacquer	

UPCHARGE	LED Lights	
----------	------------	--

MEDIA	Description		Dimensions in Inches		
	Item No.	Finish	W	H	D

SLIDING TV Unit
 1x Sliding Door & 2 Drawer
 1x Tempered Glass Shelf
 Matte Lacquer Structure/ HG Lacquer Fronts
 Accent Top & Plinth

94 1/2" 25 3/4" 21 5/8"

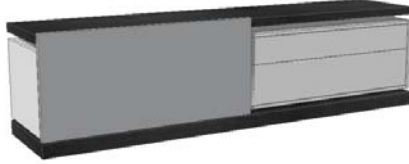

3 vol. / 1.200 m3 / 158 kg

FINISH OPTIONS		
SLIDIN-826/1	Eucalyptus Frise, Ash Burl or Natural Rosewood	
SLIDIN-826/2	Tulip Wood	
SLIDIN-826/3	Reconstituted Ebony, Oak Fume or Reconstituted Rosewood	
SLIDIN-826/4	Natural Ebony	
SLIDIN-826/5	Eucalyptus Stain	
SLIDIN-826/6	Oak (5% or 30% Sheen)	
SLIDIN-826/7	Walnut (5% or 30% Sheen)	
SLIDIN-826/8	All Lacquer	

UPCHARGE	LED Lights	
-----------------	------------	--

SLIDING TV Unit
 1x Sliding Door & 2 Drawer
 1x Tempered Glass Shelf
 Matte Lacquer Structure/ HG Lacquer Fronts
 Accent Top & Plinth

78 3/4" 25 3/4" 21 5/8"

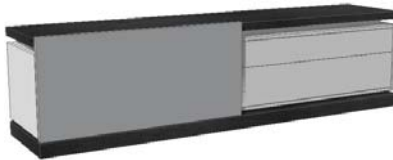

3 vol. / 0.726 m3 / 95 kg

FINISH OPTIONS		
SLIDIN-828/1	Eucalyptus Frise, Ash Burl or Natural Rosewood	
SLIDIN-828/2	Tulip Wood	
SLIDIN-828/3	Reconstituted Ebony, Oak Fume or Reconstituted Rosewood	
SLIDIN-828/4	Natural Ebony	
SLIDIN-828/5	Eucalyptus Stain	
SLIDIN-828/6	Oak (5% or 30% Sheen)	
SLIDIN-828/7	Walnut (5% or 30% Sheen)	
SLIDIN-828/8	All Lacquer	

UPCHARGE	LED Lights	
-----------------	------------	--

SLIDING TV Unit
 1x Sliding Door & 2 Drawer
 1x Tempered Glass Shelf
 Matte Lacquer Structure/ HG Lacquer Fronts
 Accent Top & Plinth

63" 25 3/4" 21 5/8"

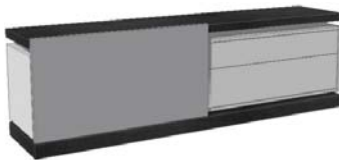

3 vol. / 0.580 m3 / 65 kg

FINISH OPTIONS		
SLIDIN-829/1	Eucalyptus Frise, Ash Burl or Natural Rosewood	
SLIDIN-829/2	Tulip Wood	
SLIDIN-829/3	Reconstituted Ebony, Oak Fume or Reconstituted Rosewood	
SLIDIN-829/4	Natural Ebony	
SLIDIN-829/5	Eucalyptus Stain	
SLIDIN-829/6	Oak (5% or 30% Sheen)	
SLIDIN-829/7	Walnut (5% or 30% Sheen)	
SLIDIN-829/8	All Lacquer	

UPCHARGE	LED Lights	
-----------------	------------	--

MEDIA	Description		Dimensions in Inches		
	Item No.	Finish	W	H	D

SLIDING TV Unit (Big Version)
 2x Drawers
 1x Tempered Glass Shelf
 Matte Lacquer Structure/ HG Lacquer Fronts
 Accent Top & Plinth

94 1/2" 18 7/8" 21 5/8"



1 vol. / 0,730 m3 / 85 Kg

FINISH OPTIONS		
SLIDIN-807/1	Eucalyptus Frise, Ash Burl or Natural Rosewood	
SLIDIN-807/2	Tulip Wood	
SLIDIN-807/3	Reconstituted Ebony, Oak Fume or Reconstituted Rosewood	
SLIDIN-807/4	Natural Ebony	
SLIDIN-807/5	Eucalyptus Stain	
SLIDIN-807/6	Oak (5% or 30% Sheen)	
SLIDIN-807/7	Walnut (5% or 30% Sheen)	
SLIDIN-807/8	All Lacquer	

UPCHARGE	LED Lights	
-----------------	------------	--

SLIDING TV Unit (Small Version)
 1x Drawer
 1x Tempered Glass Shelf
 Matte Lacquer Structure/ HG Lacquer Fronts
 Accent Top & Plinth

78 3/4" 18 7/8" 21 5/8"



1 vol. / 0,533m3 / 93 Kg

FINISH OPTIONS		
SLIDIN-830/1	Eucalyptus Frise, Ash Burl or Natural Rosewood	
SLIDIN-830/2	Tulip Wood	
SLIDIN-830/3	Reconstituted Ebony, Oak Fume or Reconstituted Rosewood	
SLIDIN-830/4	Natural Ebony	
SLIDIN-830/5	Eucalyptus Stain	
SLIDIN-830/6	Oak (5% or 30% Sheen)	
SLIDIN-830/7	Walnut (5% or 30% Sheen)	
SLIDIN-830/8	All Lacquer	

UPCHARGE	LED Lights	
-----------------	------------	--

SLIDING TV Unit (Small Version)
 1x Drawer
 1x Tempered Glass Shelf
 Matte Lacquer Structure/ HG Lacquer Fronts
 Accent Top & Plinth

63" 18 7/8" 21 5/8"

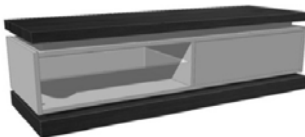

1 vol. / 0,533m3 / 93 Kg

FINISH OPTIONS		
SLIDIN-806/1	Eucalyptus Frise, Ash Burl or Natural Rosewood	
SLIDIN-806/2	Tulip Wood	
SLIDIN-806/3	Reconstituted Ebony, Oak Fume or Reconstituted Rosewood	
SLIDIN-806/4	Natural Ebony	
SLIDIN-806/5	Eucalyptus Stain	
SLIDIN-806/6	Oak (5% or 30% Sheen)	
SLIDIN-806/7	Walnut (5% or 30% Sheen)	
SLIDIN-806/8	All Lacquer	

UPCHARGE	LED Lights	
-----------------	------------	--

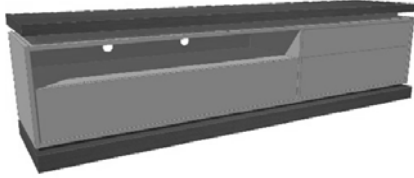
MEDIA	Description		Dimensions in Inches		
	Item No.	Finish	W	H	D
 <p>1 vol. / 1,098m3 / 155 Kg</p>	SLIDING G TV Unit 3x Drawers Matte Lacquer Structure/ HG Lacquer Fronts Accent Top & Plinth 94 1/2" 25 3/8" 21 5/8"				
	FINISH OPTIONS				
	SLIDIN-821/1	Eucalyptus Frise, Ash Burl or Natural Rosewood			
	SLIDIN-821/2	Tulip Wood			
	SLIDIN-821/3	Reconstituted Ebony, Oak Fume or Reconstituted Rosewood			
	SLIDIN-821/4	Natural Ebony			
	SLIDIN-821/5	Eucalyptus Stain			
	SLIDIN-821/6	Oak (5% or 30% Sheen)			
	SLIDIN-821/7	Walnut (5% or 30% Sheen)			
	SLIDIN-821/8	All Lacquer			
UPCHARGE	LED Lights				

WALL MOUNTED MODULES

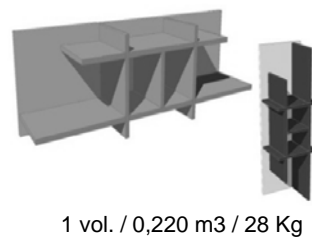

STRIPES Shelves Module Back Panel is Always in Matte Lacquer 55 1/8" 15 3/4" 13"	
STRIFE-719	All Lacquer

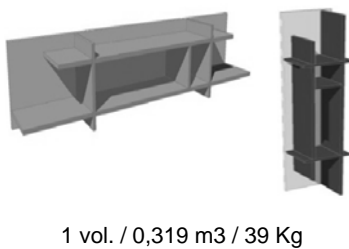

STRIPES Shelves Module Back Panel is Always in Matte Lacquer 78 3/4" 15 3/4" 13"	
STRIFE-720	All Lacquer

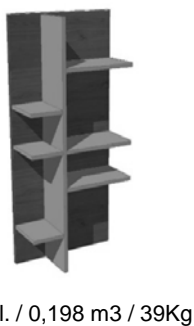

SLIDING Shelf Module Back Panel is Always in Oak (5% or 30% Sheen) 23 5/8" 49 5/8" 10 3/8"	
SLIDIN-822	Lacquer Shelves
Mirror image available upon request	

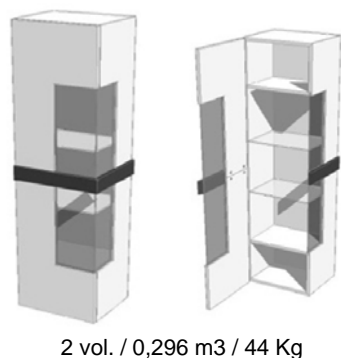

STRIPES Wall Vitrine 2x Interior Lacquer Shelves & 2x Glass Shelves Interior Light Matte Lacquer Structure/ HG Lacquer Fronts 15 3/4" 63" 13"	
STRIFE-721	All Lacquer

PLEASE NOTE: It is the responsibility of the customer to ensure that the correct hardware is used when hanging the mirror/wall modules; manufacturer cannot supply hardware for every type of situation.

*****DO NOT EXCEED 20LBS OF WEIGHT ON WALL SHELF MODULES*****

PREDESIGNED CONFIGURATIONS

Description		Dimensions in Inches		
Item No.	Finish	W	H	D

SLIDING A Composition Includes:

SLIDING TV Unit 94 1/2" W (SLIDIN-807)
 SLIDING Bar Unit 57" H (SLIDIN-801)
 STRIPES Wall Vitrine Module 63" H (STRIPE-721)
 STRIPES Shelves Module 78 3/4" W (STRIPE-720)

141 3/4" 93 3/8" 21 5/8"

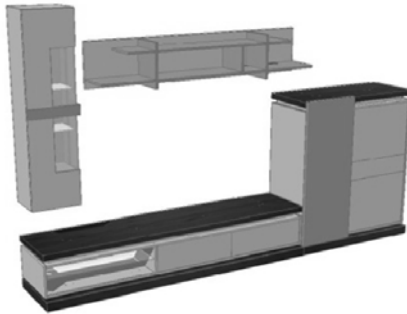

FINISH OPTIONS

SLIDIN-808/1	Eucalyptus Frise, Ash Burl or Natural Rosewood
SLIDIN-808/2	Tulip Wood
SLIDIN-808/3	Reconstituted Ebony, Oak Fume or Reconstituted Rosewood
SLIDIN-808/4	Natural Ebony
SLIDIN-808/5	Eucalyptus Stain
SLIDIN-808/6	Oak (5% or 30% Sheen)
SLIDIN-808/7	Walnut (5% or 30% Sheen)
SLIDIN-808/8	All Lacquer

UPCHARGE	LED Lights
----------	------------

SLIDING B Composition Includes:

SLIDING TV Unit 63" W (SLIDIN-806)
 SLIDING TV Unit 63" W (SLIDIN-806)
 STRIPES Wall Vitrine Module 63" H (STRIPE-721)
 STRIPES Wall Vitrine Module 63" H (STRIPE-721)

126" 93 3/8" 21 5/8"

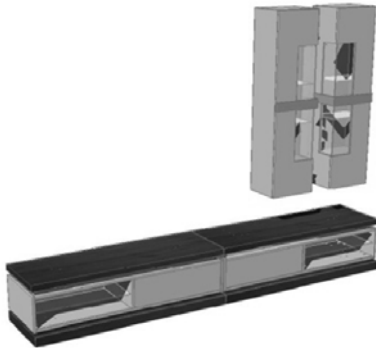

FINISH OPTIONS

SLIDIN-809/1	Eucalyptus Frise, Ash Burl or Natural Rosewood
SLIDIN-809/2	Tulip Wood
SLIDIN-809/3	Reconstituted Ebony, Oak Fume or Reconstituted Rosewood
SLIDIN-809/4	Natural Ebony
SLIDIN-809/5	Eucalyptus Stain
SLIDIN-809/6	Oak (5% or 30% Sheen)
SLIDIN-809/7	Walnut (5% or 30% Sheen)
SLIDIN-809/8	All Lacquer

UPCHARGE	LED Lights
----------	------------

SLIDING C Composition Includes:

STRIPES Wall Vitrine Module 63" H (STRIPE-721)
 STRIPES Wall Vitrine Module 63" H (STRIPE-721)
 SLIDING TV Unit 94 1/2" W (SLIDIN-807)
 SLIDING Bar Unit 57" H (SLIDIN-801)

141 3/4" 93 3/8" 21 5/8"

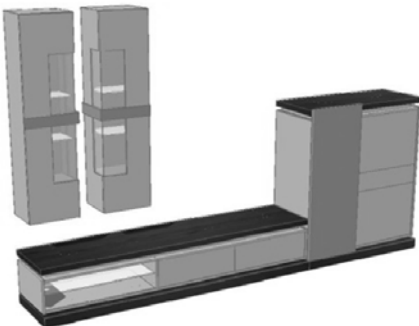

FINISH OPTIONS

SLIDIN-810/1	Eucalyptus Frise, Ash Burl or Natural Rosewood
SLIDIN-810/2	Tulip Wood
SLIDIN-810/3	Reconstituted Ebony, Oak Fume or Reconstituted Rosewood
SLIDIN-810/4	Natural Ebony
SLIDIN-810/5	Eucalyptus Stain
SLIDIN-810/6	Oak (5% or 30% Sheen)
SLIDIN-810/7	Walnut (5% or 30% Sheen)
SLIDIN-810/8	All Lacquer

UPCHARGE	LED Lights
----------	------------

PREDESIGNED CONFIGURATIONS

Description		Dimensions in Inches		
Item No.	Finish	W	H	D

SLIDING D Composition Includes:

STRIPES Shelves Module 55 1/8" W (STRIPE-719)
 STRIPES Shelves Module 55 1/8" W (STRIPE-719)
 SLIDING TV Unit 94 1/2" W (SLIDIN-807)

94 1/2" 85 1/2" 21 5/8"

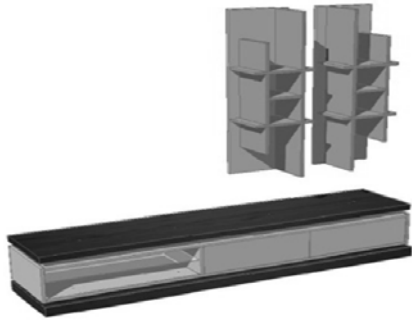

FINISH OPTIONS	
SLIDIN-811/1	Eucalyptus Frise, Ash Burl or Natural Rosewood
SLIDIN-811/2	Tulip Wood
SLIDIN-811/3	Reconstituted Ebony, Oak Fume or Reconstituted Rosewood
SLIDIN-811/4	Natural Ebony
SLIDIN-811/5	Eucalyptus Stain
SLIDIN-811/6	Oak (5% or 30% Sheen)
SLIDIN-811/7	Walnut (5% or 30% Sheen)
SLIDIN-811/8	All Lacquer

UPCHARGE	LED Lights
----------	------------

SLIDING E Composition Includes:

SLIDING TV Unit 63" W (SLIDIN-806)
 SLIDING Bar Unit 57" H (SLIDIN-801)

110 1/4" 57" 21 5/8"

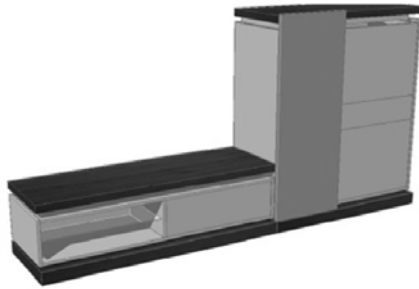

FINISH OPTIONS	
SLIDIN-812/1	Eucalyptus Frise, Ash Burl or Natural Rosewood
SLIDIN-812/2	Tulip Wood
SLIDIN-812/3	Reconstituted Ebony, Oak Fume or Reconstituted Rosewood
SLIDIN-812/4	Natural Ebony
SLIDIN-812/5	Eucalyptus Stain
SLIDIN-812/6	Oak (5% or 30% Sheen)
SLIDIN-812/7	Walnut (5% or 30% Sheen)
SLIDIN-812/8	All Lacquer

UPCHARGE	LED Lights
----------	------------

STRIPES E Composition Includes:

2x STRIPES 1 Door Vitrine (STRIPE-728)

59" 80 3/8" 17 3/4"

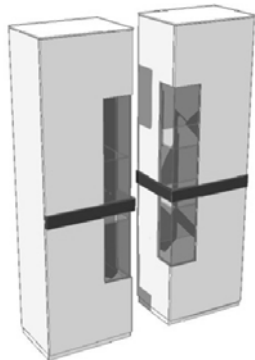

STRIPE-734	All Lacquer
------------	-------------

PREDESIGNED CONFIGURATIONS

Description		Dimensions in Inches		
Item No.	Finish	W	H	D

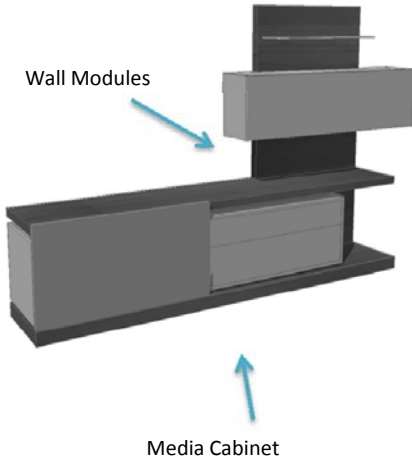

SLIDING F Composition Includes:
 w/ Drop-Lid Wall Module
 TV Unit w/ Sliding Door & 2x Drawers
 1x Tempered Glass Shelf
 Matte Lacquer Structure/ HG Lacquer Fronts
 Accent Top, Plinth & Back Panel

126" 70 7/8" 21 5/8"

FINISH OPTIONS		
SLIDIN-823/1	Eucalyptus Frise, Ash Burl or Natural Rosewood	
SLIDIN-823/2	Tulip Wood	
SLIDIN-823/3	Reconstituted Ebony, Oak Fume or Reconstituted Rosewood	
SLIDIN-823/4	Natural Ebony	
SLIDIN-823/5	Eucalyptus Stain	
SLIDIN-823/6	Oak (5% or 30% Sheen)	
SLIDIN-823/7	Walnut (5% or 30% Sheen)	
SLIDIN-823/8	All Lacquer	

UPCHARGE	LED Lights	
-----------------	------------	--

Wall Module Only
 Drop-Lid Lacquer Cabinet
 1x Tempered Glass Shelf
 Matte Lacquer Structure/ HG Lacquer Fronts
 Accent Back Panel

63" 45 1/2" 13"

FINISH OPTIONS		
SLIDIN-823W/1	Eucalyptus Frise, Ash Burl or Natural Rosewood	
SLIDIN-823W/2	Tulip Wood	
SLIDIN-823W/3	Reconstituted Ebony, Oak Fume or Reconstituted Rosewood	
SLIDIN-823W/4	Natural Ebony	
SLIDIN-823W/5	Eucalyptus Stain	
SLIDIN-823W/6	Oak (5% or 30% Sheen)	
SLIDIN-823W/7	Walnut (5% or 30% Sheen)	
SLIDIN-823W/8	All Lacquer	

114 1/4" 25 3/4" 21 5/8"

SLIDIN-823/MC	Media Cabinet Only - Combination of Lacquer & Oak	
---------------	---	--

SLIDING G Composition Includes:
 STRIPES Shelves Module 55 1/8" W (STRIPE-719)
 SLIDING G TV Unit 94 1/2" W (SLIDIN-821)
 STRIPES Shelves Module 55 1/8" W (STRIPE-719)

145 5/8" 84 1/2" 21 5/8"

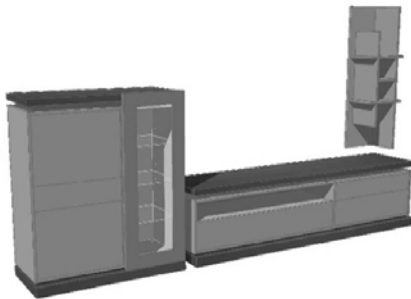

FINISH OPTIONS		
SLIDIN-824/1	Eucalyptus Frise, Ash Burl or Natural Rosewood	
SLIDIN-824/2	Tulip Wood	
SLIDIN-824/3	Reconstituted Ebony, Oak Fume or Reconstituted Rosewood	
SLIDIN-824/4	Natural Ebony	
SLIDIN-824/5	Eucalyptus Stain	
SLIDIN-824/6	Oak (5% or 30% Sheen)	
SLIDIN-824/7	Walnut (5% or 30% Sheen)	
SLIDIN-824/8	All Lacquer	

UPCHARGE	LED Lights	
-----------------	------------	--

PREDESIGNED CONFIGURATIONS

Description		Dimensions in Inches		
Item No.	Finish	W	H	D

SLIDING H Composition Includes:
 SLIDING G TV Unit 94 1/2" W (SLIDIN-821)
 SLIDING B Vitrine 82 5/8" H (SLIDIN-820)
 SLIDING Shelf Module 23 5/8"W (SLIDING-822)

141 3/4" 82 5/8" 21 5/8"

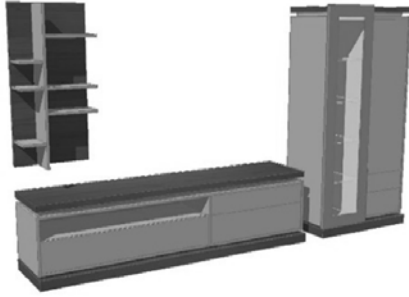

FINISH OPTIONS

SLIDIN-825/1	Eucalyptus Frise, Ash Burl or Natural Rosewood
SLIDIN-825/2	Tulip Wood
SLIDIN-825/3	Reconstituted Ebony, Oak Fume or Reconstituted Rosewood
SLIDIN-825/4	Natural Ebony
SLIDIN-825/5	Eucalyptus Stain
SLIDIN-825/6	Oak (5% or 30% Sheen)
SLIDIN-825/7	Walnut (5% or 30% Sheen)
SLIDIN-825/8	All Lacquer

UPCHARGE	LED Lights
----------	------------

OCCASIONAL

SLIDING Coffee Table

Lacquer Legs

53 1/2" 14 1/2" 33 7/8"

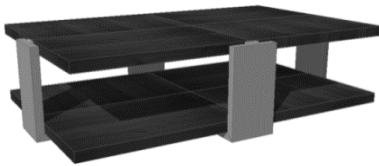

1 vol. / 0,579 m3 / 63 kg

FINISH OPTIONS

SLIDIN-813/1	Eucalyptus Frise, Ash Burl or Natural Rosewood
SLIDIN-813/2	Tulip Wood
SLIDIN-813/3	Reconstituted Ebony, Oak Fume or Reconstituted Rosewood
SLIDIN-813/4	Natural Ebony
SLIDIN-813/5	Eucalyptus Stain
SLIDIN-813/6	Oak (5% or 30% Sheen)
SLIDIN-813/7	Walnut (5% or 30% Sheen)
SLIDIN-813/8	All Lacquer

SLIDING End Table

Lacquer Legs

23 5/8" 20 1/4" 23 5/8"

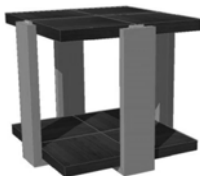

1 vol. / 0,226 m3 / 24 kg

FINISH OPTIONS

SLIDIN-814/1	Eucalyptus Frise, Ash Burl or Natural Rosewood
SLIDIN-814/2	Tulip Wood
SLIDIN-814/3	Reconstituted Ebony, Oak Fume or Reconstituted Rosewood
SLIDIN-814/4	Natural Ebony
SLIDIN-814/5	Eucalyptus Stain
SLIDIN-814/6	Oak (5% or 30% Sheen)
SLIDIN-814/7	Walnut (5% or 30% Sheen)
SLIDIN-814/8	All Lacquer