

STRIPES COLLECTION

by ALEAL



PLANUM[®]
FURNITURE

Planum, Inc
Swedesford Corporate Center
619 B Swedesford Road
Frazer, PA 19355

email info@planumfurniture.com
visit us planumfurniture.com

Tel : 610/251-2120
Tel : 800/343-0042
Fax : 610/251-2290

ALEAL Finishes

LACQUER FINISHES



LC01 BLACK

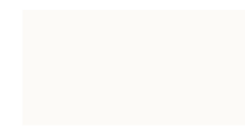

LC02 WHITE



LC07 BRICK RED



LC11 TOMATO RED



LC12 SLATE GRAY

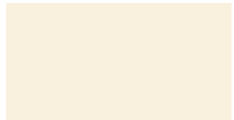

LC13 IVORY



LC14 METALLIC GRAY



LC15 GRAY BEIGE



LC16 FOG GRAY

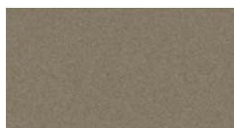

LC18 METALLIC TAUPE



LC19 CAMOUFLAGE

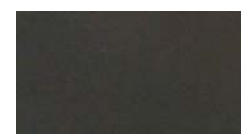

LC20 GUN METAL GRAY



LC21 MUSTARD YELLOW



LC22 ASH GRAY



LC23 SILVER GRAY



LC26 BURGANDY



LC27 RUBY

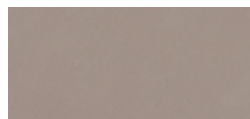

LC28 CAPPUCCINO

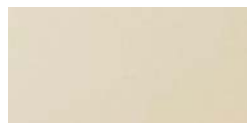

LC36 PEARL



LC37 PEWTER



LC38 PALOMINO



CHAMPAGNE



BRONZE



SILVER

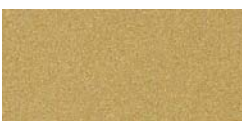

GOLD

Please Note:

- 1.) Custom RAL colors are acceptable, please add 10% upcharge (or minimum charge of \$260)
- 2.) Custom RAL colors need 60-120 day order delay.
- 3.) Is it the customers responsibility to send the sample of the desired color to Planum.
- 4.) Lastly all orders with custom colors will not be accepted as a return.

ALEAL Finishes

OAK & WALNUT FINISHES (Always 5% Sheen - Matte)



CV01 Black Oak



CV09 Gray Beige Oak



CV02 Chocolate Oak



CV12 Ivory Oak



CV03 Slate Gray Oak



CV04 White Oak



CV11 Metallic Taupe Oak



CV05 Cherry Oak



CV10 Metallic Gray Oak



CV06 Natural Oak



CVL15 Opal Gray Oak



CVL14 Steel Gray Oak



CVL16 Smooth Chocolate Oak



Wild Oak



CVL17 Rustic Oak



NG01 Walnut

Please Note: Any OAK finish can be replaced with WALNUT with a 10% upcharge

ALEAL Finishes

LEAF FINISHES



FHCH Champagne Leaf



FHOR Gold Leaf



FHPR Silver Leaf



FHBZ Bronze Leaf

TABLE OF CONTENTS

	<u>PAGE #</u>
DINING ROOM	6
VITRINE	6
BAR UNITS	6-7
MEDIA CABINETS	7
PRE-DESIGNED CONFIGURATIONS	7-9
MODULAR UNITS	9-10
WALL MOUNTED UNITS	10-11

Dining

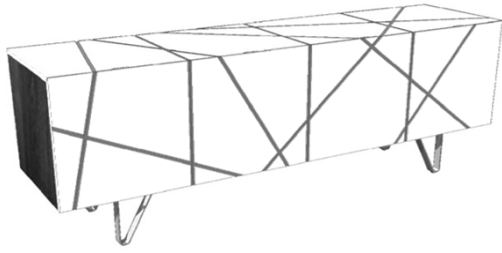

3 vol. / 0,876 m3 / 113 Kg

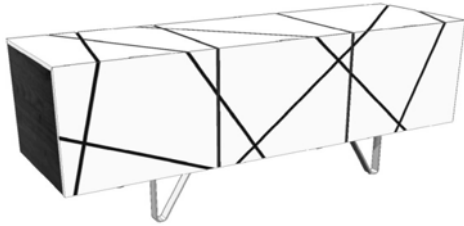

3 vol. / 0,760 m3 / 97 Kg

Description

Dimensions in Inches

Item No.	Finish	W	H	D
STRIPES Sideboard 4x Doors 2x Glass Shelves & 1x Drawer w/ Stainless Steel Legs				
		86 5/8"	31 1/2"	21 5/8"
STRIPE-700	HG Lacquer Top & Doors w/ Oak Sides; Lacquer Stripes			
UPCHARGE	Cutlery Inserts			

STRIPES Sideboard 3x Doors 2x Glass Shelves & 1x Drawer w/ Stainless Steel Legs				
		70 7/8"	31 1/2"	21 5/8"
STRIPE-701	HG Lacquer Top & Doors w/ Oak Sides; Lacquer Stripes			
UPCHARGE	Cutlery Inserts			

Vitrines

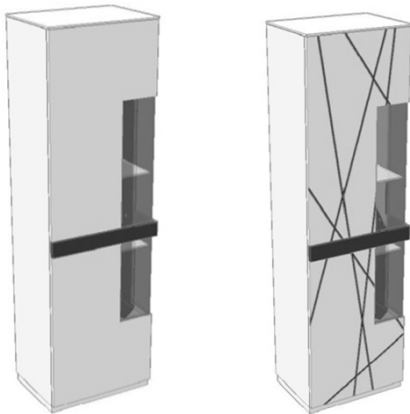

2 vol. / 0,637 m3 / 75 Kg

STRIPES 1 Door Vitrine w/out Stripes w/ Interior Light w/ Tempered Glass Shelves				
		23 5/8"	80 3/8"	17 3/4"
STRIPE-728	Matte Lacquer Structure w/ HG Lacquer Door & Handle			

Mirror image available upon request

STRIPES 1 Door Vitrine w/ Stripes w/ Lacquer Stripes in Optional Color w/ Interior Light w/ Tempered Glass Shelves				
		23 5/8"	80 3/8"	17 3/4"
STRIPE-729	Matte Lacquer Structure w/ HG Lacquer Door & Handle			

Mirror image available upon request

*** RECOMMENDED THAT UNIT BE ATTACHED TO WALL ***

Bar Unit

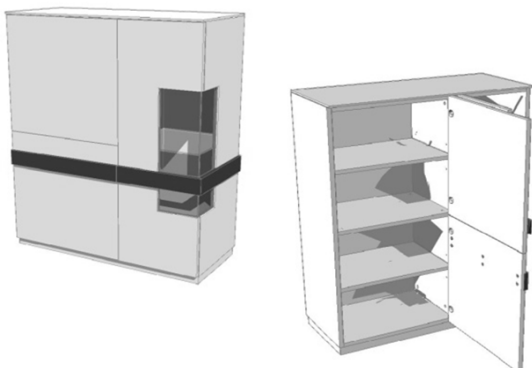

2 vol. / 0,722 m3 / 84 Kg

STRIPES Vitrine Bar w/out Stripes w/ Lacquer Shelves w/ LED Projector				
		39 3/8"	49 1/4"	17 3/4"
STRIPE-726	Matte Lacquer Structure w/ HG Lacquer Door & Handle			

Mirror image available upon request

*** RECOMMENDED THAT UNIT BE ATTACHED TO WALL ***

Bar Unit

Description

Dimensions in Inches

Item No.	Finish	W	H	D
----------	--------	---	---	---

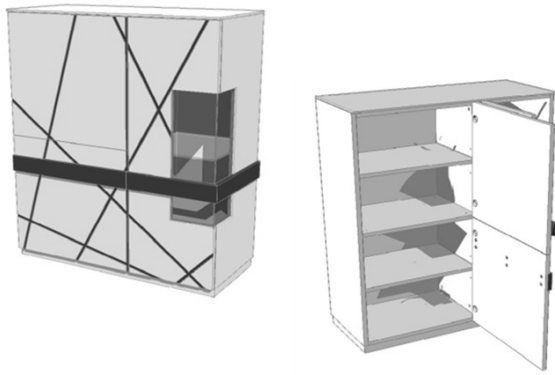

STRIPES Vitrine Bar w/ Stripes
 w/ Lacquer Stripes in Optional Color
 w/ Lacquer Shelves
 w/ LED Projector

39 3/8"	49 1/4"	17 3/4"
---------	---------	---------

STRIPE-727	Matte Lacquer Structure w/ HG Lacquer Door & Handle
-------------------	---

Mirror image available upon request

*** RECOMMENDED THAT UNIT BE ATTACHED TO WALL***

2 vol. / 0,722 m3 / 84 Kg

Media Cabinet

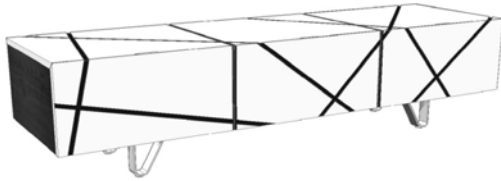

STRIPES Media Cabinet
 w/ 2x Drawers & 1x Drop-lip
 w/ Stainless Steel Legs

63"	16 1/2"	18 1/8"
-----	---------	---------

STRIPE-703	HG Lacquer Top & Doors w/ Oak Sides; Lacquer Stripes
-------------------	--

2 vol. / 0,360 m3 / 66 Kg

Pre-Designed Configurations

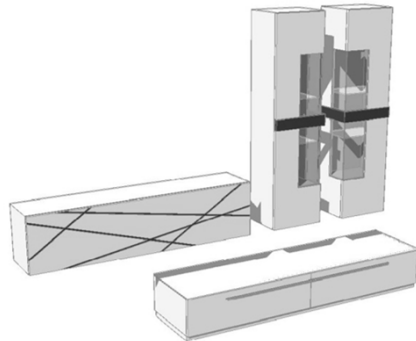

STRIPES Composition A Includes:
 Drop Lid Door Module 63" W (STRIPES-718)
 Wall Vitrine Module 63" H (STRIPE-721)
 Wall Vitrine Module 63" H (STRIPE-721)
 Low Base 78 3/4" W (STRIPE-708)

118 1/8"	87 7/8"	20 5/8"
----------	---------	---------

STRIPE-730	Combination of Matte & HG Lacquer
-------------------	-----------------------------------

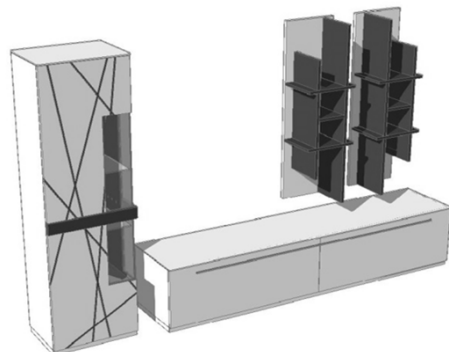

STRIPES Composition B Includes:
 1 Door Vitrine 80 3/8" H (STRIPE-729)
 High Base 94 1/2" W (STRIPE-712)
 Shelf Module 55 1/8" W (STRIPE-719)
 Shelf Module 55 1/8" W (STRIPE-719)

126"	80 3/8"	20 5/8"
------	---------	---------

STRIPE-731	Combination of Matte & HG Lacquer
-------------------	-----------------------------------

Pre-Designed Configurations

Description

Dimensions in Inches

Item No.	Finish	W	H	D
STRIPES Composition C Includes: Wall Vitrine Module 63" H (STRIPE-722) Wall Vitrine Module 63" H (STRIPE-722) Plinth 47 1/4" W (STRIPE-713) High Base 94 1/2" W (STRIPE-712) Shelf Module 55 1/8" W (STRIPE-719) Shelf Module 55 1/8" W (STRIPE-719)				
		141 3/4"	82 3/4"	20 5/8"
STRIFE-732	Combination of Matte & HG Lacquer			
STRIPES Composition D Includes: Wall Vitrine Module 63" H (STRIPE-721) Shelf Module 78 3/4" W (STRIPE-720) Stacking Platform 78 3/4" W (STRIPE-724) Low Base 78 3/4" W (STRIPE-708) Vitrine Bar (STRIPE-727)				
		118 7/8"	96"	20 5/8"
STRIFE-733	Combination of Matte & HG Lacquer			
STRIPES Composition E Includes: 2x 1 Door Vitrine (STRIPE-728)				
		59"	80 3/8"	17 3/4"
STRIFE-734	Combination of Matte & HG Lacquer			
STRIPES Composition F Includes: 1 Door Vitrine (STRIPE-728) Shelf Module 78 3/4" W (STRIPE-720) Stacking Platform 63" W (STRIPE-723) Low Base 63" W (STRIPE-707) Vitrine Bar (STRIPE-727)				
		126"	80 3/8"	20 5/8"
STRIFE-735	Combination of Matte & HG Lacquer			
STRIPES Composition G Includes: Vitrine Bar (STRIPE-727) Shelf Module 78 3/4" W (STRIPE-720) Low Base 78 3/4" W (STRIPE-708) Wall Vitrine Module 63" H (STRIPE-721)				
		118 1/8"	87 7/8"	20 5/8"
STRIFE-736	Combination of Matte & HG Lacquer			

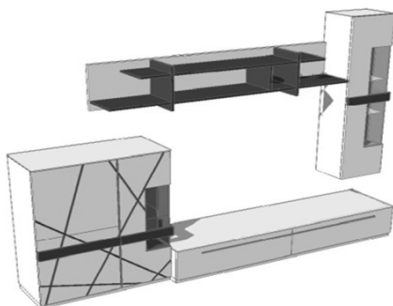
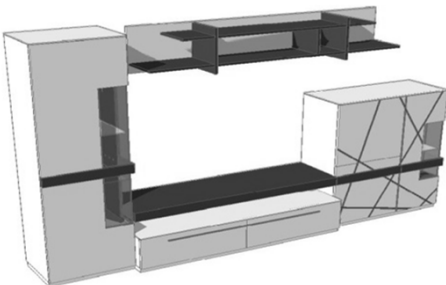
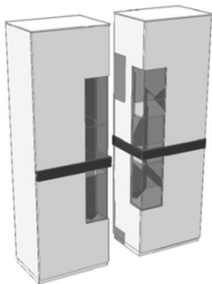
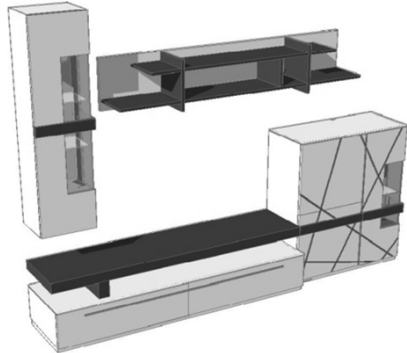
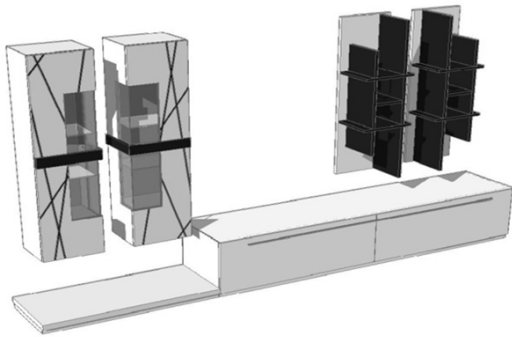

Pre-Designed Configurations

Description

Dimensions in Inches

Item No.	Finish	W	H	D
STRIPES Composition H Includes: High Base 78 3/4" W (STRIPE-711) Plinth 47 1/4" W (STRIPE-713) Shelf Module 55 1/8" W (STRIPE-719) Wall Vitrine Module 63" H (STRIPE-722) Wall Vitrine Module 63" H (STRIPE-722)				
		126"	87 7/8"	20 5/8"
STRIFE-737	Combination of Matte & HG Lacquer			

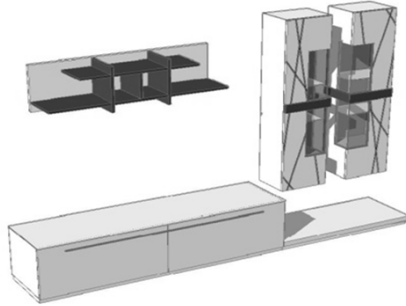

Modular Units - Low Base

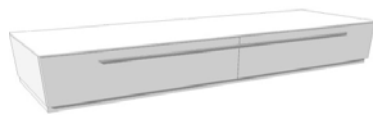

1 vol. / 0,277 m3 / 61 Kg

STRIPES Low Base - 63"W 2x Drawers				
		63"	13"	20 5/8"
STRIFE-707	Matte Lacquer Structure w/ HG Lacquer Fronts			

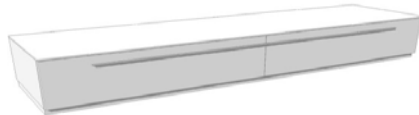

1 vol. / 0,448 m3 / 76 Kg

STRIPES Low Base - 78 3/4"W 2x Drawers				
		78 3/4"	13"	20 5/8"
STRIFE-708	Matte Lacquer Structure w/ HG Lacquer Fronts			

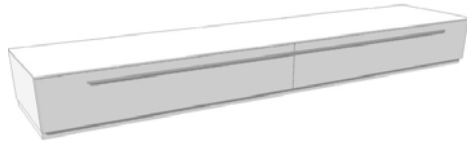

1 vol. / 0,416 m3 / 91 Kg

STRIPES Low Base - 94 1/2"W 2x Drawers				
		94 1/2"	13"	20 5/8"
STRIFE-709	Matte Lacquer Structure w/ HG Lacquer Fronts			

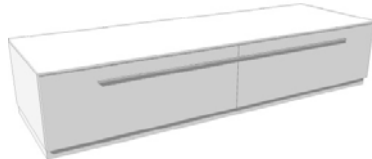

1 vol. / 0,420 m3 / 74 Kg

STRIPES High Base - 63"W 2x Drop-Lids & Interior Shelves 1x Pull-out shelf on right side				
		63"	19 3/4"	20 5/8"
STRIFE-710	Matte Lacquer Structure w/ HG Lacquer Fronts			

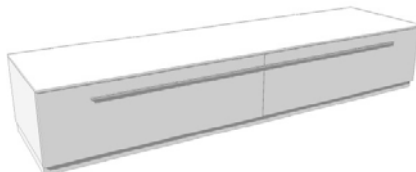

1 vol. / 0,716m3 / 92 Kg

STRIPES High Base - 78 3/4"W 2x Drop-Lids & Interior Shelves 1x Pull-out shelf on right side				
		78 3/4"	19 3/4"	20 5/8"
STRIFE-711	Matte Lacquer Structure w/ HG Lacquer Fronts			

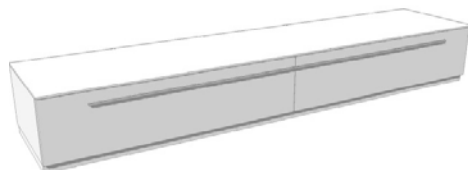

1 vol. / 0,630 m3 / 110 Kg

STRIPES High Base - 94 1/2"W 2x Drop-Lids & Interior Shelves 1x Pull-out shelf on right side				
		94 1/2"	19 3/4"	20 5/8"
STRIFE-712	Matte Lacquer Structure w/ HG Lacquer Fronts			

Free Standing Plinths

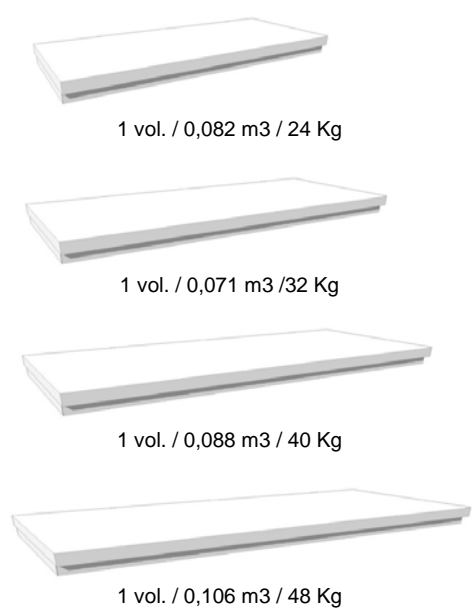

Description		Dimensions in Inches		
Item No.	Finish	W	H	D
STRIPES Plinth - 47 1/4"W		47 1/4"	3 3/8"	20 1/2"
STRIPE-713	Matte Lacquer			
STRIPES Plinth - 63"W		63"	3 3/8"	20 1/2"
STRIPE-714	Matte Lacquer			
STRIPES Plinth - 78 3/4"W		78 3/4"	3 3/8"	20 1/2"
STRIPE-715	Matte Lacquer			
STRIPES Plinth - 94 1/2"W		94 1/2"	3 3/8"	20 1/2"
STRIPE-716	Matte Lacquer			

Stacking Platform w/ Spacer



STRIPES Stacking Platform - 63"W		63"	8 1/4"	18"
STRIPE-723	Matte or HG Lacquer			
1 vol. / 0,153 m3 / 24 Kg				
STRIPES Stacking Platform - 78 3/4"W		78 3/4"	8 1/4"	18"
STRIPE-724	Matte or HG Lacquer			
1 vol. / 0,148 m3 / 30 Kg				
STRIPES Stacking Platform - 94 1/2"W		94 1/2"	8 1/4"	18"
STRIPE-725	Matte or HG Lacquer			
1 vol. / 0,229 m3 / 36 Kg				

Wall Mounted Modules

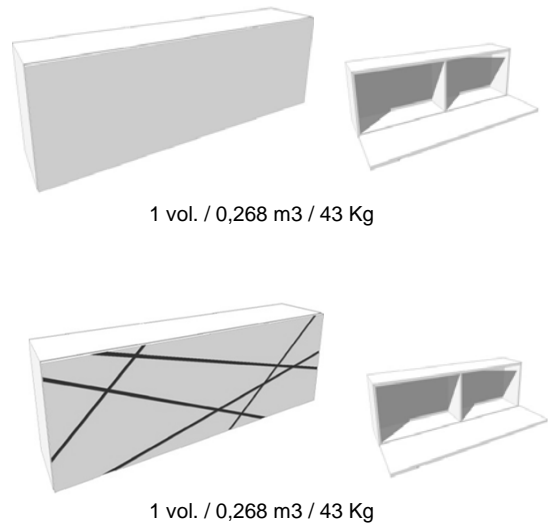

STRIPES Drop-Lid Module w/out Stripes		63"	15 3/4"	13"
STRIPE-717	Matte Lacquer Structure w/ HG Lacquer Fronts			
Available w/ Pull-Up door upon request				
STRIPES Drop-Lid Module w/ Stripes w/ Lacquer Stripes in Optional Color		63"	15 3/4"	13"
STRIPE-718	Matte Lacquer Structure w/ HG Lacquer Fronts			
Available w/ Pull-Up door upon request				

Wall Mounted Modules

Description

Dimensions in Inches

Item No.	Finish	W	H	D
----------	--------	---	---	---

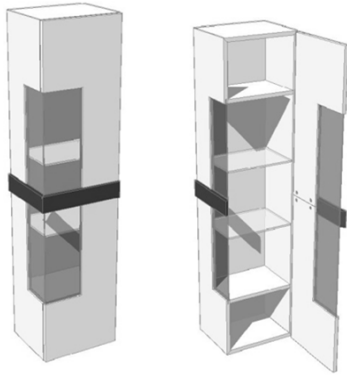

STRIPES Wall Vitrine w/out Stripes
w/ Interior Light
w/ Tempered glass shelves

15 3/4"	63"	13"
---------	-----	-----

STRIFE-721	Matte Lacquer Structure w/ HG Lacquer Door & Handle	
-------------------	---	--

Mirror image available upon request

2 vol. / 0,296 m3 / 44 Kg

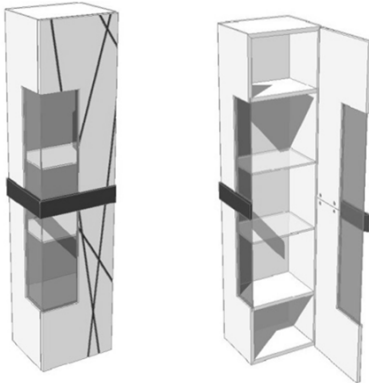

STRIPES Wall Vitrine w/ Stripes
w/ Lacquer Stripes in Optional Color
w/ Interior Light
w/ Tempered Glass Shelves

15 3/4"	63"	13"
---------	-----	-----

STRIFE-722	Matte Lacquer Structure w/ HG Lacquer Door & Handle	
-------------------	---	--

Mirror image available upon request

2 vol. / 0,296 m3 / 44 Kg

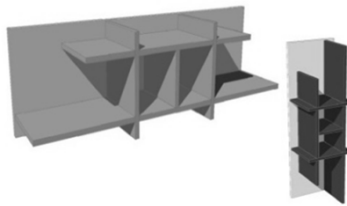

STRIPES Shelf Module

55 1/8"	15 3/4"	13"
---------	---------	-----

STRIFE-719	HG Lacquer Shelves w/ Matte Lacquer Back	
-------------------	--	--

1 vol. / 0,220 m3 / 28 Kg

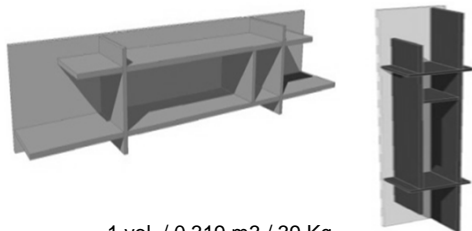

STRIPES Shelf Module

78 3/4"	15 3/4"	13"
---------	---------	-----

STRIFE-720	HG Lacquer Shelves w/ Matte Lacquer Back	
-------------------	--	--

1 vol. / 0,319 m3 / 39 Kg



SLIDING Shelf Module

23 5/8"	49 5/8"	10 3/8"
---------	---------	---------

SLIDIN-822	HG Lacquer Shelves w/ Oak Back	
-------------------	--------------------------------	--

PLEASE NOTE: It is the responsibility of the customer to ensure that the correct hardware is used when hanging the mirror/wall modules; manufacturer cannot supply hardware for every type of situation.