

# BELVEDERE 0443A-M1

## Designed for KELVIN GIORMANI

**4D**

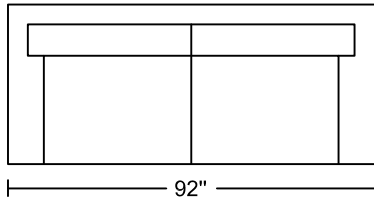

**4D3**

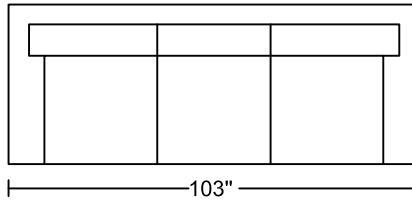

**3D**

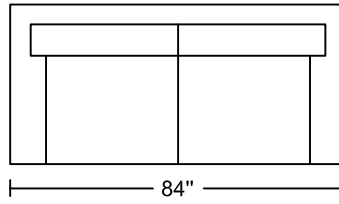

**2.5D**

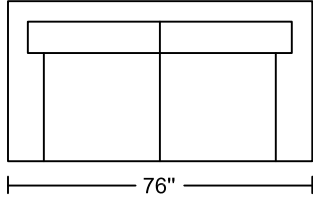

**1.5D**

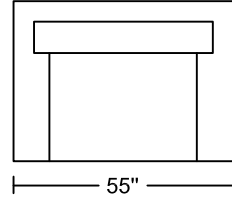

**1DV1**

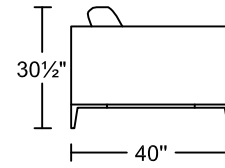
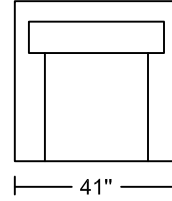

**4RA/LAF**

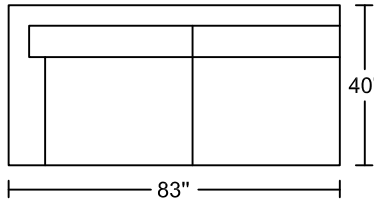

**3RA/LAF**

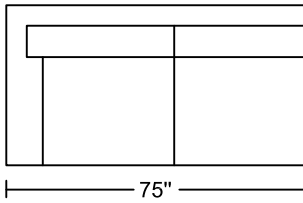

**2.5RA/LAF**

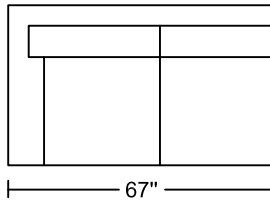

**1.5RA/LAF**

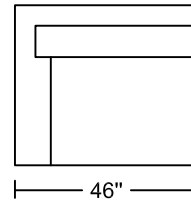

**1RA/LAF**

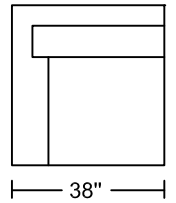

**4LA/RAF**

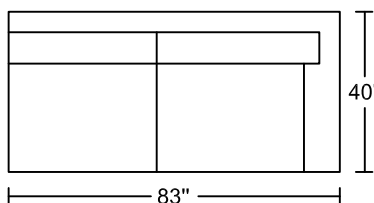

**3LA/RAF**

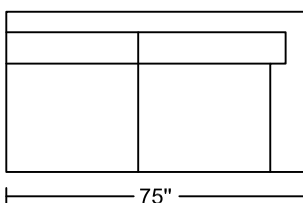

**2.5LA/RAF**

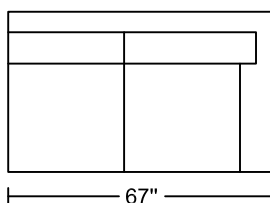

**1.5LA/RAF**

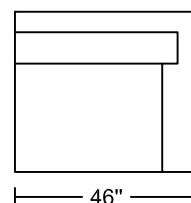

**1LA/RAF**

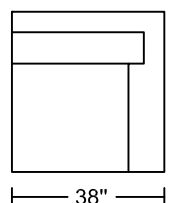

**4C**

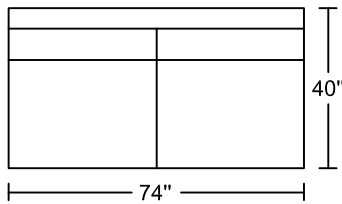

**3C**

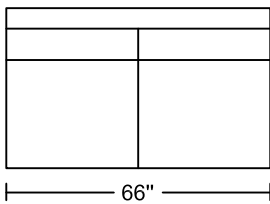

**2.5C**

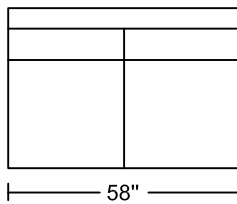

**1.5C**

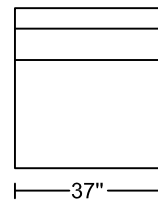

**SXR/LAF**

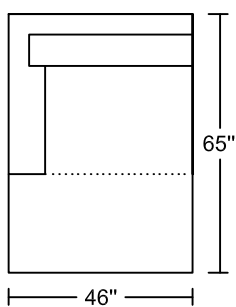

**SXL/RAF**

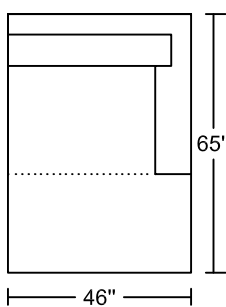

**JXR/LAF**

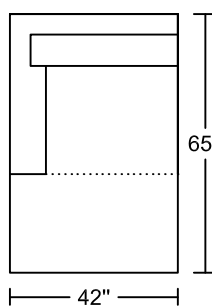

**JXL/RAF**

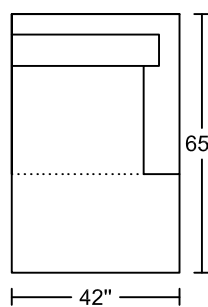

---

# BELVEDERE 0443A-M1

---

## Designed for KELVIN GIORMANI

---

**LXR/LAF**

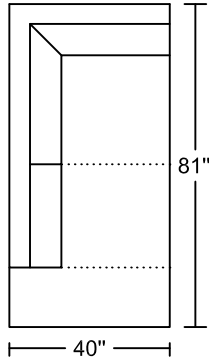

**LXL/RAF**

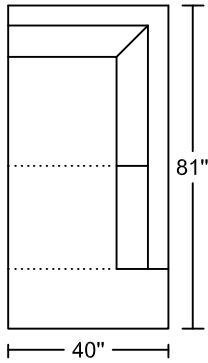

**CN**

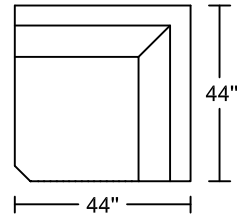

**CUN**

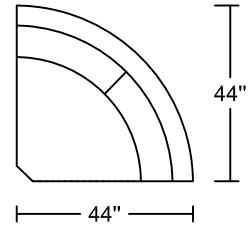

**3RAE/LAF**

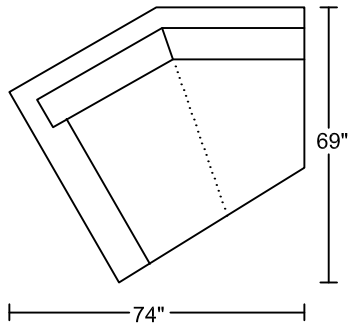

**3LAE/RAF**

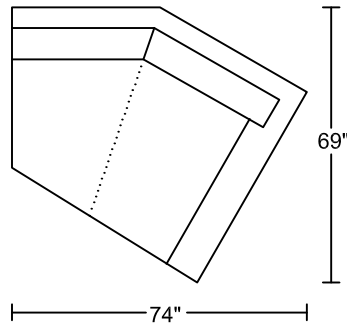

**ST1**

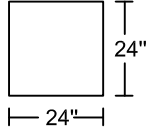

**ST1**

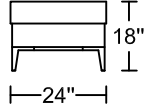

**ST2**

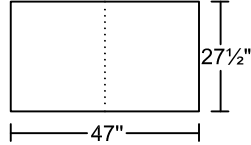

**ST2**

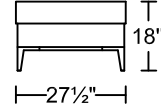

**HR1**

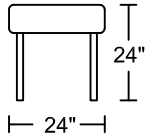

**HR2**

